

# MSI-4260

*Port-A-Weigh Crane Scales*

## Technical Manual





# Contents

- 1.0 Introduction..... 1**
  - 1.1 Features ..... 1
  - 1.2 Safety ..... 2
  - 1.3 Display..... 3
    - 1.3.1 Keypad Functions..... 3
    - 1.3.2 Annunciators and LEDs ..... 4
  - 1.4 Options ..... 4
- 2.0 Installation ..... 5**
  - 2.1 Unpacking ..... 5
  - 2.2 Battery Pack ..... 5
    - 2.2.1 Battery Life ..... 5
    - 2.2.2 Battery Charger ..... 6
    - 2.2.3 Battery Replacement ..... 7
  - 2.3 Communications Port ..... 7
    - 2.3.1 Communications Port Cables ..... 7
  - 2.4 Servicing ..... 8
  - 2.5 RF Connectivity ..... 9
  - 2.6 FCC Statement ..... 9
- 3.0 Operation..... 10**
  - 3.1 Navigation of Menus ..... 10
  - 3.2 Power ..... 10
  - 3.3 Zero..... 10
  - 3.4 Tare..... 11
- 4.0 Setup ..... 12**
  - 4.1 Setup Menu ..... 12
    - 4.1.1 Set Function Key ..... 13
    - 4.1.2 Test ..... 13
    - 4.1.3 Total ..... 14
    - 4.1.4 View Total..... 14
    - 4.1.5 Net / Gross..... 14
    - 4.1.6 Learn ..... 14
    - 4.1.7 Peak Hold ..... 14
    - 4.1.8 Units..... 14
    - 4.1.9 Print ..... 15
  - 4.2 Auto- Off ..... 15
  - 4.3 Sleep..... 15
  - 4.4 Display Brightness..... 16
  - 4.5 Setpoints..... 16
  - 4.6 Total ..... 17
  - 4.7 Filter Setup ..... 18
  - 4.8 Unit ..... 19
  - 4.9 Battery Life ..... 19



Technical training seminars are available through Rice Lake Weighing Systems. Course descriptions and dates can be viewed at [www.ricelake.com/training](http://www.ricelake.com/training) or obtained by calling 715-234-9171 and asking for the training department.

<b>5.0</b>	<b>Calibration .....</b>	<b>19</b>
	5.1 Calibration Switch Access .....	19
	5.2 Standard Calibration .....	19
	5.3 Initial Calibration .....	20
	5.4 Guidelines for Capacity and Resolution .....	21
	5.5 C-Cal Calibration .....	22
	5.6 Calibration Setup Menu .....	23
	5.6.1 Standard Menu .....	23
	5.7 Auto Zero Maintenance .....	24
<b>6.0</b>	<b>RF Remote Control Option.....</b>	<b>25</b>
	6.1 Description .....	25
	6.2 Functions .....	25
	6.3 Setting the Transmitter Address .....	25
	6.4 Setting the Receiver Address .....	26
	6.4.1 Resetting the 4260 RF Remote Receiver .....	26
	6.5 Conflict and Jamming Considerations .....	26
	6.6 Battery Replacement .....	26
	6.7 RF Remote Control FCC Statement .....	27
<b>7.0</b>	<b>Communications Setup.....</b>	<b>28</b>
	7.1 RF Network Setup .....	28
	7.1.1 802.15.4 RF Network Setup .....	28
	7.2 Ethernet Setup .....	29
	7.3 Printer / Serial Output Setup .....	30
	7.3.1 Control Modes .....	30
	7.3.2 Standard Print Strings .....	30
	7.3.3 Printer Output Setup .....	31
<b>8.0</b>	<b>Troubleshooting/Maintenance.....</b>	<b>33</b>
	8.1 Troubleshooting .....	33
	8.2 Service Counters .....	34
	8.2.1 Access the Service Counters: .....	34
	8.3 MSI-4260 Port-A-Weigh Dimensions .....	35
<b>9.0</b>	<b>Specifications.....</b>	<b>36</b>



Rice Lake continually offers web-based video training on a growing selection of product-related topics at no cost. Visit [www.ricelake.com/webinars](http://www.ricelake.com/webinars)

# 1.0 Introduction

---

The *MSI-4260 Port-A-Weigh* has an established reputation as the industry standard in medium to heavy-capacity overhead weighing and duty-cycle needs. With a proven mechanical design and advanced electronics, the *MSI-4260* is versatile, reliable, accurate and user friendly.

The *MSI-4260* is designed to meet or exceed requirements of applicable ASME, ANSI, OSHA safety standards. Multiple options and accessories, including RF remote control and RF remote display (using the *MSI-8000* remote display) are available to further enhance the performance and application versatility of the *MSI-4260*.



This manual can be viewed or downloaded from the Rice Lake Weighing Systems website at [www.ricelake.com/manuals](http://www.ricelake.com/manuals)

Warranty information can be found on the website at [www.ricelake.com/warranties](http://www.ricelake.com/warranties)

## 1.1 Features

- Designed to meet or exceed applicable U.S. and international safety standards.
- Provides up to 40 hours of weighing time, utilizing automatic sleep mode.
- Automatic power off conserves battery life by sensing no activity after a set number of minutes, which is set by the operator and turns off the power.
- Automatic sleep mode preserves the battery life by dimming the LED display after a set number of minutes of no activity.
- Has rugged construction throughout. The buttons are sealed and rated for over 1 million operations.
- Precise high resolution (2500 division standard and up to 10,000 possible) 24 bit A/D conversion coupled with advanced RISC micro controller, provides world class features and accuracy.
- Display includes five large, 1.2" (30.5 mm) LED digits for clear weight readings from a distance. The display is always tilted down for easier viewing from below.
- Is easy to maintain: full digital calibration assures reliable, repeatable measurements. It can be calibrated without test weights using the **C-Cal** technology.
- Is selectable for kg/lb unless prohibited by Legal for Trade regulations.
- Provides automatic or manual weight totalization for loading operations.
- Is easily customized for special applications and using oversized attachments and interface hardware.
- Hi speed Peak mode for wire and rope stress analysis.
- Eight setpoints can be set for any in-range weight for operator alerts or process control.
- Includes ScaleCore technology providing quick and easy software updates and calibration/setup backup.
- Two service counters ensure load train safety by warning the user to perform a load train safety check when the lift count gets high or the scale has been overloaded repeatedly.

## 1.2 Safety

### Safety Symbol Definitions



**DANGER**

Indicates an imminently hazardous situation that, if not avoided, will result in serious injury or death.



**WARNING**

Indicates a potentially hazardous situation that, if not avoided, could result in serious injury or death.



**CAUTION**

Indicates a potentially hazardous situation that, if not avoided, could result in minor/moderate injury.



**Important**

Indicates information about procedures that, if not observed, could result in damage to equipment or corruption/loss of data.

### General Safety

---



Do not operate or work on this equipment unless you have read and understand the instructions in this manual. After reading, store it in a safe place for future reference. Incorrect handling of this product could possibly result in personal injury or physical damage. The manufacturer assumes no responsibility for any damage caused by mishandling that is beyond normal usage defined in this manual.



*Failure to heed may result in serious injury or death.*

*Do not allow minors (children) or inexperienced persons to operate this unit.*

*Do not stand near the load being lifted as it is a potential falling hazard. Keep a safe distance.*

*Do not use for purposes other than weight taking or dynamic load monitoring.*

*Do not use any load bearing component that is worn beyond five percent of the original dimension.*

*Do not use the scale if any of the components of the load train are cracked, deformed or show signs of fatigue.*

*Do not exceed the rated load limit of the scale, rigging elements or the lifting structure.*

*Do not allow multi-point contact with the hook, shackle or lifting eye of the scale.*

*Do not allow high torque on the scale unless it is specifically designed for high torque.*

*Do not make alterations or modifications to the scale or associated load bearing devices.*

*Do not use improperly rated or sized shackles. Use only Rice Lake Weighing Systems recommended shackles.*

*Do not remove or obscure warning labels.*

*For guidelines on the safe rigging and loading of overhead scales and dynameters, read the MSI Crane Scale Safety and Periodic Maintenance Manual (available at [www.ricelake.com](http://www.ricelake.com)).*

*Keep hands, feet and loose clothing away from moving parts.*

*There are no user serviceable parts within the MSI-4260. Any repairs are to be performed by qualified service personnel only.*

*The MSI-4260 Port-A-Weigh scale has a safe mechanical overload of 200 percent and an ultimate overload of 500 percent. Overloads greater than 50 percent could result in structural failure and dropped loads. Dropped loads could cause serious personal injury or death.*

## 1.3 Display

The keys and display of the *MSI-4260* front panel is described below.



Figure 1-1. *MSI-4260 Front Panel*

### 1.3.1 Keypad Functions





Key	Description
	Power Key — Turns the <i>MSI-4260</i> On and Off.
	Zero Key — Used to zero out residual weight on the scale.
	Tare Key — Removes the weight of containers, trucks or carriers and places the scale in the Net weight mode.
	User Key— Programmable to user selectable functions. See Section 3.0 on page 10. This key is defaulted to the Test function.

Table 1-1. *Key Functions*

### 1.3.2 Annunciators and LEDs

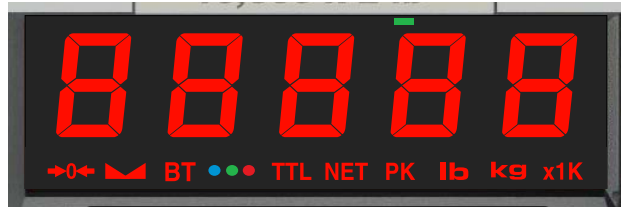

Annunciator	Description
→0←	Center of Zero — Indicates that the scale is zeroed and the weight is within 1/4d of zero.
▲▲	Stable — Indicates that the weight has settled within the motion window (usually $\pm 1d$ ). When this symbol is off, the scale will not zero, tare or totalize.
BT	Low Battery — displays when 10% of battery life remains. LED blinks indicating automatic shutdown will occur.
● ● ●	<b>SET POINTS</b> — eight user programmable setpoints for early overload warnings. Blue LED = Setpoint 1, Green LED = Setpoint 2, Red LED = Setpoint 3
TTL	Total — blue LED indicates the the total weight is displayed for five seconds or less.
NET	Net — indicates the scale is in Net mode. Tare weight has been subtracted from the gross weight.
PK	Peak — indicates the scale is in peak hold mode.
kg	kg — red LED indicates weight display is in kilograms.
lb	lb — red LED indicates weight display is in pounds.
x1K	X1000 — blue LED is used in conjunction with the TOTAL LED, allowing weight accumulation beyond the 5-digit display capacity.
■	Acknowledge — green LED is used to provide feedback to the operator that incoming remote commands have been received. Also used for acknowledging successful Auto-Total operations.
88888	The main display digits include five, 1.2" (30.5 mm) brightness LED load display.

Table 1-2. Annunciators and LEDs

## 1.4 Options

Part No.	Option	Description
150972	Wireless Remote Controller Kit	50' (15 m) typical range Line-of-Sight. Uses 418 MHz (USA) hand-held transmitter. 315 MHz and 433 MHz options are available for international applications. Includes Modem and Controller
139386	Spare Wireless Remote Controller	Controller Only
150971	Wireless RF Option	RF Modem for wireless connectivity. Uses 802.15.4, 2.4GHz For Communication with MSI RF Scalecore Products
173014	RF Rugged Remote Controller	100' (30 m) typical range Line-of-Sight. Uses 802.15.4, 2.4GHz. Hand-held transceiver. Requires scale with installed P/N:150971 Wireless RF option.
139381	MSI-8000 RF Handheld Remote Display	300' (100m) typical range Line-of-Sight. Uses 802.15.4, 2.4GHz Requires scale with installed P/N:150971 Wireless RF option.
153591	MSI-8000HD RF Mountable Remote Display	300' (100m) typical range Line-of-Sight. Uses 802.15.4, 2.4GHz Requires scale with installed P/N:150971 Wireless RF option.
151095	MSI-8000 Audible Alarm	Is triggered by setpoint one. Uses Scale's modem port, must be in remote display if one is present
Consult	802.11 Wi-Fi Connectivity	Wi-Fi Ethernet Network Communication
Consult	85-265 VAC input power	Replaces 12V SLA Battery with Hardwired AC Power Cord
Consult	Audible Alarm	Is triggered by setpoint one. Takes up Scale's modem port, must be in remote display if one is present

Table 1-3. Available Options



## 2.0 Installation

The *MSI-4260* features a heavy duty, cast aluminum enclosure rated at NEMA Type 4 IP 66. It installs easily by hanging it on a crane using properly sized shackles.



*Refer to the Crane Scale Safety and Periodic Maintenance Manual (PN 153105) for safe loading and rigging guidelines when installing the model MSI-4260.*

*Regular maintenance inspections of the lifting system should be performed to ensure safety. Pay particular attention for signs of stress on any element in the load train.*

Use the appropriate interface hardware for the capacity of the scale.

- If the interface hardware does not fit properly, Rice Lake Weighing Systems can supply the *MSI-4260* with oversize lifting eyes or shackle interfaces.
- If the crane hook is too large to fit in the lifting eye with single point interface, then install the scale using adaptive rigging.
- If multiple attachments are needed, use a shackle or ring to attach the multiple lines to keep a single point attachment to the scale.



**Important** *Using an oversize shackle or hook to interface with the *MSI-4260* can cause off center loading and stress points that will reduce the life of the lifting eye or hook.*

*Single point attachments are necessary to ensure the safety and accuracy of the scale system.*

### 2.1 Unpacking

When unpacking the *MSI-4260*, ensure that all assembly parts are accounted for. Check the *MSI-4260* for any visible damage. If any parts were damaged in shipment, notify Rice Lake Weighing Systems and the shipper immediately. If the *MSI-4260* must be returned, it must be properly packed with sufficient packing materials. Whenever possible, use the original carton when shipping the unit back.

### 2.2 Battery Pack

The *MSI-4260* is powered by a 12V Sealed Lead Acid (SLA) rechargeable battery. This battery will operate for up to 100 hours (depending on LED brightness setting) before requiring recharging.

Charging time for a completely discharged battery is up to eight hours. A spare battery pack is recommended to keep the *MSI-4260* in continuous operation.



**Important** *To obtain maximum service life from the batteries they should be stored between -4°F and 122°F (-20°C and +50°C). Stored batteries should be recharged every three months. The battery is fully charged when the status indicator on the battery charger is flashing.*

#### 2.2.1 Battery Life

The battery life of the *MSI-4260* depends on a number of factors:

- The brightness of the LED display and number of segments lit
- The amount of RF activity
- The age of the battery
- The condition of the SLA battery.

In order to conserve battery life, the *MSI-4260* includes the following features.

- **Automatic Power Off Mode** — senses no activity after the set amount of minutes and turns the scale off.
- **Automatic Sleep Mode** — dims the display after a set amount of minutes of no scale activity.

The *MSI-4260* automatically turns off when the SLA battery drops to approximately 10.5V. Recharge the battery when this happens, SLA batteries benefit from frequent recharging and can be recharged when it still has available life.

Due to the maintenance discharge imposed on the battery by the *MSI-4260* electronics, do not store the *MSI-4260* with the battery inside. Remove the battery if it will not be used for more than two weeks.



**Important** *Leaving a discharged battery in the scale, which has a maintenance battery drain, can result in a deep discharged battery which will shorten its service life.*

## Note

- If the scale is in continuous use, a fully charged spare battery is recommended. Replace the drained battery as close as possible to the low battery warning.
- SLA batteries that have not been deep discharged should withstand 500 to 1500 charging cycles.
- The low battery warning annunciator will indicate about two to four hours of additional use before the MSI-4260 turns itself off.
- If the MSI-4260 is not going to be used again soon, remove the SLA battery to prevent deep discharge while the unit is in storage.
- Recycle the battery at an authorized recycling center when the average life drops to 20 hours or less.

## 2.2.2 Battery Charger

The MSI-4260 is shipped with a battery charger designed to charge and maintain the battery. Exact charging time will depend on the degree of discharge of the battery. A battery removed when the low battery warning first appears should take about four hours to fully charge.

## Note

When the battery is new, it might take significantly longer for the initial charge. It is recommended to charge a new battery for 24 hours. It might take several charge/discharge cycles before full capacity is reached. Deep discharged batteries will also take significantly longer to charge.

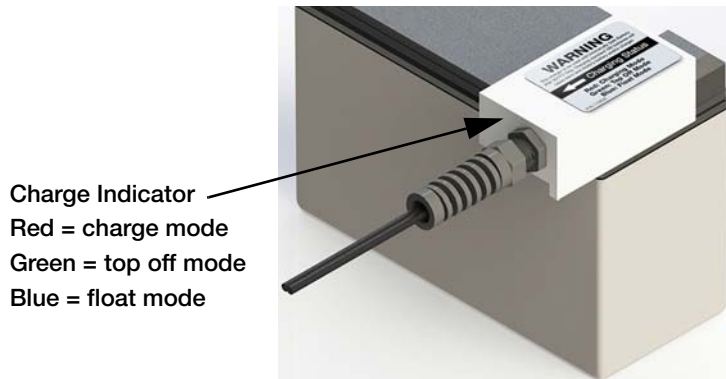

Figure 2-1. Battery Charger Connected to Battery

The battery charger is a universal input type that is a three-stage float charger that can be left on the battery indefinitely. It is rated for 100-240VAC, 50-60Hz. It has a dual color LED to indicate the charging state.

- Red – charge mode.
- Green – top off mode.
- Blue – Float (fully charged) mode

If the status light remains green when the battery is first plugged in, the battery may be defective. Use the following steps to charge a battery.

1. Remove the battery from the MSI-4260. See Figure 2-2 on page 7.
2. Connect the charger assembly to the AC power supply (86-260VAC). The charge indicator light should be green.

## Note

If the power status light fails to illuminate, check the AC power connection to ensure the V in the jack is fully seated. AC power cords suitable for any world location are available from Rice Lake Weighing Systems.

3. Plug the polarized connector into the jacks on the battery.
4. The charge status light should turn **RED** indicating fast charge.
5. Charge until the status light turns **GREEN**. This indicates the charger is in top off mode. The battery has sufficient charge for use. The charger and battery are in float charge mode when the charge indicator turns **BLUE**.

When the charge cycle is complete, the battery can be left on the charger until it is needed. The charger keeps a maintenance float charge on the battery to ensure the best possible operation times.



**Important** To obtain maximum service life from the batteries, the manufacturer suggests recharging after each 20 hours of use. Continuous deep discharging reduces maximum battery life cycle estimated at 2000 cycles.

## 2.2.3 Battery Replacement

1. Turn the *MSI-4260* off.
2. Secure the battery cover.
3. Release the latches holding the battery cover.
4. Slowly lower the cover while holding the battery in place.
5. Remove the battery by pulling straight back.
6. Install a fully charged battery by plugging it in to the exposed battery jacks.
7. Close the battery cover.
8. Reset the latches. Make sure the latches are completely latched and the cover is firmly in place.



Figure 2-2. Remove Battery



**Important** Periodically, inspect the battery latches for fit. Adjust the screw latch by rotating the catch on its threads to maintain a tight seat on the battery O-ring.



**CAUTION** The 12V Sealed Lead Acid battery can be a dangerous falling hazard. When opening the battery hatch, be sure to hold the battery to prevent it from falling. These batteries contain lead and should be recycled when it has reached its end of life.

## 2.3 Communications Port

The *MSI-4260* has a single Communications Port allowing access to the embedded ScaleCore through the terminal access mode or Rice Lake software. The terminal access mode is used for updating scale firmware while Rice Lake software can be used for calibration and configuration, backup and adjusting scale settings. This Communications Port is not intended for output use.

### 2.3.1 Communications Port Cables

The *MSI-4260* comes standard with one communications port cable wired for RS-232 following the AT standard for 9-pin serial cables (DCE). An un-terminated cable is also available for wiring the serial cable for RS-232.

Table 2-1 shows the wiring color code.

Signal	Wire Color
TxD (transmitted data)	Brown
RxD (received data)	Black
CTS (clear to send)	Grey
RTS (request to send)	White
GND	Blue
PG (protective ground)	Drain Wire

Table 2-1. RS-232 Wiring Code

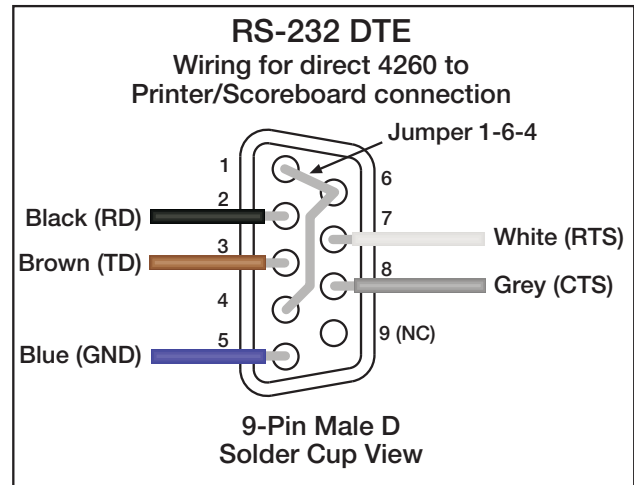
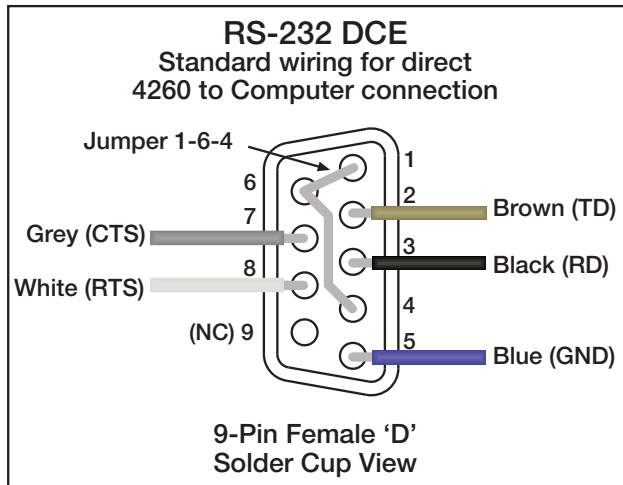

Figure 2-3. Comm Port Cable Assignments Examples

## 2.4 Servicing

Rice Lake's dealer network provides both on-site and depot servicing of *MSI-4260* crane scales. Please contact a local dealer or Rice Lake Weighing Systems to obtain a return material authorization (RMA). Due to the weight and size of many of the product, it is not always necessary to return the whole scale. There are no user serviceable parts inside the *MSI-4260*. Depot repair is performed with module and harness swaps.

If the electronics are at fault, often the front casting section is all that needs to be returned. See Figure 2-4.



Figure 2-4. Remove Front Casting

To remove front casting electronics package:

1. Remove four cap screws.
2. Unplug connectors.
3. Package the front casting well for safe shipping.

## 2.5 RF Connectivity

The *MSI-4260* has options for RF connectivity:

1. 802.15.4 – Standards based DSSS (Direct Sequence Spread Spectrum) connection at 2.4 GHz This is used for connectivity to MSI's Model 8000 hand held remote display. It can also be used with a 802.15.4 modem to connect to scoreboards or computers. Due to it being very commonly ordered, it is included in this manual.
2. 802.11b,g,n – Standards based DSSS WiFi connection at 2.4 GHz. For operation on an 802.11 Access Point to Ethernet networks. Detailed in the option's manual.

## 2.6 FCC Statement

### Contains FCC ID: OUR-XBEEPRO

The *MSI-4260* complies with Part 15 of the FCC rules. Operation is subject to the following two conditions:

- (i.) this device may not cause harmful interference.
- (ii.) this device must accept any interference received, including interference that may cause undesired operation.

### International RF Certs (for 802.15.4 Option)

**Canada** Radio Cert. No.: IC: 4214A-XBEEPRO

**Australia & New Zealand:** AS4268:3000

**Japan:** Certificate of Radio Equipment in Japan No.: 08215111/AA/02

**Europe and much of Asia:**

The product is compliant with the following standards and/or other normative documents:

Safety (article 3.1A) EN60950-1:2001

EMC (article 3.1b) ETSI EN 301 489-1 v1.7.1 (2007-04) In accordance with the specific requirements of ETSI EN 301 489-17 v1.2.1 (2002-08)





Spectrum (article 3.2) ETSI EN 300 328 v1.7.1 (2006-10)

## 3.0 Operation

---

The following sections describe the basic operation of the *MSI-4260*.

### 3.1 Navigation of Menus

- If a function key does not work, it is probably because the *MSI-4260* is not set up to support the key. For example, if the Function Key is set for **TOTAL**, the **TOTAL** mode must also be set up in the Setup Menu.
- When in Setup menus,  drops back one menu level. At the root menu level, the  stores the changes and returns to the weight mode.
- When in Setup menus,  returns directly to the Weight Display without storing the changes.
- When in Setup menus,  functions as the scroll key.
- When in Setup menus,  functions as the **ENTER/SELECT** key.

### 3.2 Power

To turn on the power, press . The following will display in order:

- The LEDs will light all segments at full brightness as a display test.
- Display brightness will change to the setting determined in the Display Menu.
- The software version number will display.
- The *MSI-4260* is ready for use.

### 3.3 Zero

The zero key sets the zero reading of the scale. Press  to take out small deviations in zero when the scale is unloaded. See Section 3.4 on page 11 for zeroing (taring) a package or pallet weights.



**Note** *The scale digits display 0 (or 0.0 or 0.00, etc).  
The backup memory in the MSI-4260 stores the zero reading and retains it even if the power fails.*

#### Rules for Use:



- Works in **GROSS** or **NET** mode.
- Zeroing while in net mode will zero the gross weight causing the display to show a negative tare value.
- The scale must be stable within the motion window. The scale will not zero if the stabilizer annunciator is off. The scale will remember that it has a zero request for two seconds. If a motion ceases within the motion window in that time, the scale will zero.
- The scale will accept a zero setting over the full Range of the scale (NTEP and other Legal for Trade models may have a limited zero range). Zero settings above four percent of full scale will subtract from the overall capacity of the scale.

*Example: If 100 lb on a 1000 lb scale is zeroed, the overall capacity of the scale will reduce to 900 lb, plus the allowed over-range amount.*

## 3.4 Tare

Tare is used to zero out a known weight such as a packing container or pallet and display the load in NET weight.

A Tare value is entered by pressing . The TARE function is defined as a Tare-In, Tare-Out operation.

The first press of  stores the current weight as a tare value and then the scale subtracts the tare value from the gross weight and changes the display to NET mode. The next press of  will clear the Tare value and revert the display to GROSS mode.

To view the Gross weight without clearing the Tare Value, program  to the function NET/GROSS.

The RF Remote Control has a Net/Gross permanently available.

To tare and display the net weight, press .



- Note**
- The weight reading must be stable within the motion window for the tare function to work.*
  - The scale digits display 0 (or 0.0 or 0.00, etc) and the weight mode changes to NET.*
  - The backup memory in the MSI-4260 stores the Tare reading and can restore it even if power fails.*

To clear the tare and revert to gross weight, press . **GROSS** will display.







- Only positive gross weight readings can be tared.
- The  must be off indicating weight reading is stable.
- Setting or changing the tare has no effect on the gross zero setting.
- Taring will reduce the apparent over range of the scale.

*Example: Taring a 100 lb container on a 1000 lb scale, the scale will overload at a net weight of 900 lb (1000-100) plus any additional allowed overload (usually ~four percent or 9d).*



- The scale stores the tare value in non-volatile memory and is restored when power is cycled.

## 4.0 Setup

The following keys can be used when navigating through the menus while setting up the *MSI-4260*.

- Press  to exit setup without saving changes. *CRANE* displays momentarily and unit enters weigh mode.
- To enter a decimal point, press  while the digit is blinking.
- Press  to save and go back one level. Press it again to leave the setup mode, *SCALE* will display briefly when entering weigh mode.
- If a wrong value is entered, press  to step back one digit and press  to change the digit.
- Press  to enter or select a parameter.
- Press  to scroll through the parameters.

### 4.1 Setup Menu

To enter into the *MSI-4260* setup menu, press  and  simultaneously.

Parameters	Choices	Description
Func 1 Func 2	OFF	Function User Key 1 – user definable key that can be programmed to one of several functions
		Function User Key 2 – user definable key that can be programmed to one of several functions. Only available on the RF remote being used with the MSI-4260.
	TEST	Test Display – Section 4.1.2 on page 13
	TOTAL	Total – Section 4.1.3 on page 14
	VIEW TOTAL	View Total – function always available on the RF Remote, see Section 4.1.4 on page 14
	NET/GROSS	Net/Gross – function always available on the RF Remote, Section 4.1.5 on page 14
	RF REMOTE LEARN	RF Remote Learn – Section 4.1.6 on page 14
	PEAK HOLD	Peak Hold – Section 4.1.7 on page 14 Function not available or non-functional in OIML R76 or NTEP HB44 modes
	UNITS	Units – See Section 4.1.8 on page 14 Function not available or non-functional in OIML R76 & 1Unit modes
PRINT	Print – Section 4.1.9 on page 15	
AUTO OFF	OFF 15 30 45 60	Auto Off Time – prolongs battery life of scale by turning power off after the set time (in minutes) that the scale is not in use See Section 4.2 on page 15
SLEEP	OFF 5 15 30	Sleep – Time (in minutes) before unit will enter the sleep mode See Section 4.3 on page 15
DISPLAY	L0-1 L0-2 H1-1 H1-2 Auto	LED Display Intensity – used to set the display brightness See Section 4.4 on page 16
SETPOINT 1-8	OFF CRATE LESS	Setpoint 1 to 8 – used for warnings or process control See Section 4.5 on page 16

Table 4-1. Function Key Settings









Parameters	Choices	Description
TOTAL	OFF EELON A. LOAD A. LAST A. HIGH	Total Mode – accumulation of multiple weighments See Section 4.6 on page 17
FILTER	OFF LO HI - 1	Weight Filter – allows the scale to adjust to situations where there may be movement See Section 4.7 on page 18
UNIT	Lb KG	Weight Units – toggle units between pounds and kilograms Function not available or non-functional in OIML R76 & 1Unit modes See Section 4.8 on page 19
BATTERY	STAND LONG	Battery Life – sets the options for standard or extended battery life. See Section 4.9 on page 19



Table 4-1. Function Key Settings

### 4.1.1 Set Function Key

The MSI-4260 has one user definable key () on the front panel, that can be programmed to one of several functions. The additional function key is available on the RF remote control being used.

To set the function key use the following steps:

1. Press and hold  and . *FUNC 1* is displayed.
2. Press . The current user key function is displayed.
3. Press the  to scroll through the available functions.
4. Press  when the desired function is displayed. *FUNC 2* displays.
5. Press . *STORE* displays, the unit exits setup and stores the settings.

 **Note** Press  at any time to cancel the procedure.

### 4.1.2 Test

To run a test, press the **F** key which is programmed to **TEST**. The display will automatically scroll through the following:

- Lights all LEDs at once.
- Displays *Soft* followed by the software version number.
- Displays *batt* followed by the battery voltage.
- Displays *d. test* followed by the display counting from 00000 to 99999.
- Displays *C-CAL* followed by the C-CAL value.

Other internal tests are performed and if any test fails, an error code will display. See Section 8.1 on page 33 for information on the troubleshooting guide.











To stop the automatic test procedure, press the **F**-key again within two seconds to enable a single step mode. Use the

**F**-key to scroll through the available test functions and  to start or display the individual tests.

Press  to exit individual tests, press it again to exit from the test function.

### 4.1.3 Total

Set the total parameter desired for the F-key.

1. If the unit is turned off, press and hold  then press .  
If the unit is on, press  and  simultaneously. *Func 1* will display.
2. Using the , scroll to *TOTAL*.
3. Press . The currently saved total mode is displayed.
4. Press  to scroll through the choices.
5. With choice displayed, press  to select. *FLTR* is displayed.
6. Press  to save and exit to weighing mode or press  to continue to another setup menu item.



**Note** *The Total mode must be programmed from the Setup Menus before the USER key will function.*

### 4.1.4 View Total

The F-key activates the total weight display followed by the number of samples. With the Total weight is displayed press ZERO to clear.

### 4.1.5 Net / Gross

Switches the display between net and gross modes. Net weight is defined as gross weight minus a tare weight.



**Note** *RF Remote Control, and the MSI-8000 have this function as a standard feature. On the MSI-8000, an F-key must be configured to Net/Gross Mode to enable this feature.*

To switch between net mode and gross mode, press the F-key (set to net/gross function). This will only work if a tare value has been established.

The operator can switch back to gross from net without clearing the tare value. Only clearing or setting a new tare will change the tare value held before switching into Gross Mode.

OIML Legal for Trade units only: The NET/GROSS key is a temporary action only. The gross weight is displayed for two seconds and then the display returns to the net mode. The only way to return to permanent gross readings is to clear the tare. See Section 3.4 on page 11.

### 4.1.6 Learn

Learn is used for programming the RF remote control. This function is detailed in Section 6.0 on page 25.

### 4.1.7 Peak Hold

Peak hold will only update the display when a higher peak weight reading is established.

The peak hold function uses a high speed mode of the A/D converter allowing it to capture transient weights at a far higher rate than typical scales. Peak hold is cleared and re-enabled with the F-key.

Peak hold is not available on NTEP or OIML Legal for Trade certified scales.

### 4.1.8 Units

Units can be changed in two ways.

- Program a user function key to units
- Change the units with the setup menu using the following steps.



**Note** *Unit switching is not available on OIML certified Legal for Trade scales.*







### 4.1.9 Print



If a print option is installed this menu choice will appear. The setup of the print function is covered in the option manual.

## 4.2 Auto- Off

The *Auto-Off* feature prolongs the battery life by powering off the unit when not in use. Whenever a button is pressed or the detected load is in motion exceeding 10d, the time limit is reset. When disabled, the unit will remain on and only turn off when the power key is pressed or the battery dies.

Use the following steps to set the Auto-Off function:







1. Press and hold  and . *Func 1* will display.
2. Press the  to scroll to *A-OFF*.
3. Press . The current *A-OFF* time is displayed.
4. Press the  to scroll through the available times.
5. Press  when the desired time is displayed. *SLEEP* displays.
6. Press  to exit setup and store the settings.



 **Note** Press  at any time to cancel the procedure.

## 4.3 Sleep

The *Sleep* parameter reduces power consumption by automatically turning off the display during periods of inactivity. While in the sleep mode, the green acknowledge annunciator will blink at a one second rate to indicate the unit is in sleep mode. To wake up the unit, either a button must be pushed (front panel or RF remote) or the weight must change by 5 d or more.

 **Note** *Sleep* must be set to less time than the *Auto-Off* timer.

1. Press and hold  and . *Func 1* will display.
2. Press the  to scroll to the *SLEEP* function.
3. Press . The current *SLEEP* time is displayed.
4. Press the  to scroll through the available times.
5. Press  when the desired time is displayed.
6. Press  to exit setup and store the settings.





 **Note** Press  at any time to cancel the procedure.

## 4.4 Display Brightness



The *Display* setup menu is used to set the display brightness. There are four fixed brightness settings and one automatic light sensing brightness setting.



Auto setting will automatically detect the ambient light and adjust the brightness of the display accordingly. Bright light will cause the display to be at the brightest setting. The display brightness will reduce as ambient light reduces.

There are four fixed brightness settings, *LO-1*, *LO-2*, *HI-1* and *HI-2*. Lower brightness settings increase battery life.

1. Press and hold  and . *FUNC 1* will display.
2. Press the  to scroll to the *DISPL*.
3. Press . The current setting is displayed.
4. Press the  to scroll through the available settings.

 **Note** *The display brightness changes when each setting is displayed.*

5. Press  when the desired setting is displayed. *SETPt 1* displays.
6. Press  to exit setup and store the settings.

 **Note** *Press  at any time to cancel the procedure.*

## 4.5 Setpoints

The *MSI-4260* supports eight setpoints. Common uses of setpoints are for warnings or process control. It comes standard with LED outputs for a triggered set point.



Setpoint 1 is Blue  
Setpoint 2 is Green  
Setpoint 3 is Red











*Figure 4-1. Setpoint LED's*



The *MSI-4260* has an audible output option that is triggered by Setpoint 1. Contact Rice Lake Weighing Systems for other setpoint output options.



Setpoint	Description
<b>Setpoint Mode</b>	
GREATER	Indicates the setpoint will trigger when the weight exceeds a set value
LESS	Indicates the setpoint will trigger when the weight is less than a set value
<b>Setpoint Weight Type</b>	
NETGR	responds to net or gross weight
GROSS	responds to gross weight regardless of the display
TOTAL	responds to the totaled weight
T-CNT	responds to the total count (number of samples)
LFCNT	responds to the number of times the weight has exceeded 25% of capacity



*Table 4-2. Available Setpoint Settings*

To set the setpoint:

1. Press and hold  and . *Func 1* is displayed.
2. Press  to scroll to the desired setpoint (*SetPt 1 - 0*).
3. Press . The current *SetPt* mode is displayed.
4. Press  to scroll to the setpoint mode desired.
5. Press . The current *SetPt* weight type is displayed.
6. Press  to scroll to the desired weight type.
7. Press . The current setpoint weight value is displayed.
8. Press . The first digit will blink.
9. Press  to scroll to the desired number.
10. Press . The second digit will blink.
11. Repeat steps 8-10 until the desired value is displayed.

 **Note** To enter a decimal point, press  while the digit is blinking. To correct a digit, press  to step back.

12. Press . The value will stop blinking and the next setup menu item is displayed.
13. Repeat steps 2-12 to set all the setpoints to be used.
14. Press  to exit setup and store the settings.

 **Note** Press  at any time to cancel the procedure.

## 4.6 Total

For the accumulation of multiple weighments, the **Total** function used the displayed load, so gross and net readings can be added into the same total.

There are four modes of totalizing: manual and three auto modes. The manual mode requires the **TOTAL** key be pressed with the weight on the scale. The weight will be added to the previously accumulated value. This assures that a weight on the scale is only added to the total once.

Both the manual and three auto total modes require that the weight on the scale return below 0.5 percent (relative to full scale) of **GROSS ZERO** or **NET ZERO** before the next weighment can be added. Applied weight must be  $\geq 1$  percent of full scale above **GROSS ZERO** or **NET ZERO** before it can be totaled.

### Manual Total

The **USER** key under the **MANUAL TOTAL** mode functions in this manner:

- **Weight is greater than one percent of capacity and has not been totaled** – Pushing the **USER** key will add the current weight to the **TOTAL** weight. The **ACK LED**'s blink to indicate the weight was accepted. The **TOTAL** annunciator lights and the Total weight is displayed for five seconds and then the number of samples is displayed for two seconds.

- **Current Weight has been totaled** – Pushing the **USER** key will display the Total weight for five seconds (View Total) without changing the Total value. The **TOTAL** annunciator will light during the **TOTAL** weight display. After five seconds of Total Weight display, the number of samples is displayed for two seconds.
- **Weight is less than one percent of capacity** – The **USER** key functions as View Total only and functions as View Total until the one percent threshold is exceeded to allow the next addition to the total value.

## Auto Total

The **USER** key under the **AUTO TOTAL** mode functions as Auto Total On / Auto Total Off.

The Auto Mode has three variations which are programmed in the Setup menu:

- **A. Load – AutoLoad** ensures any settled load above the **Rise above** threshold will be automatically totaled. The scale must fall below the **Drop below** threshold before the next total is allowed.
- **A. Last – AutoLast** mode takes the last settled weight to auto total with. The total occurs only once the scale goes below the threshold. This allows the load to be adjusted without a total occurring. Once the load is removed, the scale uses the last settled reading for total.
- **A. High – AutoHigh** uses the highest settled reading. This is useful for loads that can't be removed all at once.



**Note** Total Mode will not function while the scale is in motion, make sure is on. If the system fails to achieve stable readings, increase the filter setting or increase the size of the scale division (d) in the Init Cal procedure.

## Set Total Mode



1. If the unit is turned off, press and hold then press . If the unit is on, press and simultaneously. **Func 1** will display.
2. Using the , scroll to **SetTL**.
3. Press . The currently saved total mode is displayed.
4. Press to scroll through the choices.
5. With choice displayed, press to select. **Filter** will be displayed.
6. Press to save and exit to weighing mode or press to continue to another setup menu item.

## 4.7 Filter Setup

Changing the filter settings allows the scale to adjust to situations where there is a lot a movement in the structure. If the reading is not stable, it can often be improved by increasing the filter setting. Settling time will be longer as the filter setting is increased. However, the **MSI-4260** employs algorithms that speed up large weight changes while still controlling vibration even with high filter settings.

Use the following steps to set up filtering.





1. If the unit is turned off, press and hold then press . If the unit is on, press and simultaneously. **Func 1** will display.
2. Using the , scroll to **Filter**.
3. Press . The currently saved total mode is displayed.
4. Press to scroll through the choices.
5. With choice displayed, press to select. **Unit** will be displayed.

6. Press  to save and exit to weighing mode or press  to continue to another setup menu item.



## 4.8 Unit

1. Press and hold  and . *FUNC 1* will display.







If the unit is on, press  and  simultaneously. *FUNC 1* will display

2. Press  to scroll to *Unit*.
3. Press  to enter *Unit*.
4. Press  to toggle between lb and kg.
5. With the desired choice displayed, press  to select.
6. Press  to save and exit to weighing mode.

## 4.9 Battery Life

1. If the unit is turned off, press and hold  then press .

If the unit is on, press  and  simultaneously. *FUNC 1* will display.

2. Using the , scroll to *b. LIFE*.
3. Press . The currently saved total mode is displayed.
4. Press  to toggle between the choices.
5. With choice displayed, press  to select. *FUNC 1* will display.
6. Press  to save and exit to weighing mode or press  to continue to another setup menu item.

## 5.0 Calibration

The *MSI-4260* is calibrated using standard weights. It is required that the weight used is at least 10 percent of full capacity in order to achieve rated accuracy. For example, use at least a 500 kg test weight to calibrate a 5000 kg capacity scale. Although a single span point is usually adequate for rated accuracy, the *MSI-4260* supports Multi-Point calibration with up to four span points plus zero.

When adequate test weights are not available, the *MSI-4260* can be calibrated using a calculated constant calibration which is referred to as C-Cal. To use C-Cal, a previously generated C-Cal number must be known. MSI supplies replacement load cells for the *MSI-4260* with the C-Cal value stamped on the serial number label.

There are three kinds of calibration:

- **Standard Calibration** – this is used for maintenance and routine calibration.
- **Initial Calibration** – is used to set up both the capacity and resolution (d) of the scale. It differs from Standard Calibration only in the initial steps. The initial calibration is performed after a calibration reset which completely erases the calibration and setup memory.
- **C-Cal** – If the last calculated C-Cal values is known, the *MSI-4260* can be calibrated without weights.

### 5.1 Calibration Switch Access

Use the following steps to access the calibration switch on the *MSI-4260* if calibrating the unit using either the standard calibration or the C-Cal calibration.

1. Remove the hex seal screw from the *MSI-4260*.

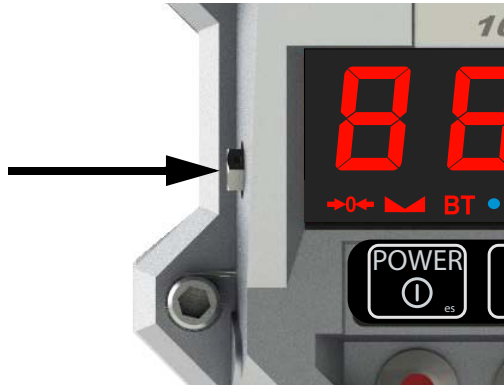







Figure 5-1. Calibration Switch Seal Screw

2. Using a small screwdriver, press the Cal switch located behind the hex seal screw.  $\square$  is displayed.



### 5.2 Standard Calibration



Use the following steps to calibrate the *MSI-4260* using the standard calibration procedure.

1. Press ,  $U_nLd$  will display.
2. Press  when the scale becomes motionless, a blinking  $\square$  is displayed.
3. If the scale is in range  $PRSS$  is displayed, then  $LdPd$  is displayed.
4. Load the scale with a test weight (for a single span point calibration, a test weight of more than 20 percent of capacity or more is recommended).
5. Press . The current capacity flashes on the display. If loading the scale with the capacity weight, skip to step 8.
6. Press  if using a calibration weight other than capacity. The displays far left digit will blink indicating a number should be entered.
7. Press  to scroll the numbers and  to enter each digit.















*Example: Enter 2500 kg on a 5000 kg capacity scale.*

Press  two times for the leftmost blinking digit, press  to save that digit selection.

Press  five times for the next blinking digit, press  to save that digit selection.

Press  to save that digit selection.





Press  to save the next digit selection. 2500 is displayed.











8. Press  to save the weight entry. If the cal value is within limits, *PASS* is briefly displayed then *Load2*.
9. Press  if more cal points are desired or  if a single point cal is needed.
10. Load the scale the next test weight and press  if the weight value is acceptable.
11. Press  to scroll through digit choices and press  to enter the calibration weight value.
12. Press  again to complete the calibration span point. If the cal value is within limits, *PASS* is briefly displayed, then *Load3* or *Load4* is displayed.
13. Press  to enter an additional span point or  if finished and the display will show *CAL d* to indicate that the calibration was successful.
14. Press  and the display flashes *C-CAL* followed by the *C-CAL* number.
15. Press  to store the calibration and *SETUP* is displayed.
16. Press  to exit the calibration menus and start up the standard weight display.
17. Replace the hex seal screw that was removed in “Calibration Switch Access” on page 19.

### 5.3 Initial Calibration

Use this procedure only if the capacity and count-by (d) needs to be modified. The initial steps of the initial calibration will totally erase user setup as well as any previous calibration.

Use the following steps to calibrate the *MSI-4260* using the initial calibration procedure.

1. Turn the *MSI-4260* off.
2. Remove the hex seal screw using the steps in Section 5.1 on page 19.
3. Press the **Cal** switch and the **Power** switch on the unit simultaneously and display reads *rESEt*.
4. Press and hold  to reset the calibration constants. *Setup* is displayed.
5. Press  to complete the reset and *CAL* is displayed.
6. Press  to start the initial calibration and *Unit* is displayed.
7. Press  to select the calibration unit.

8. Press  to choose between lb and kg and then press .
9. Press  to enter the capacity setting. A capacity of 10000 is the initial value and should not be set no higher than the load cell rated capacity.
10. Press  to change the capacity and the first digit on the display blinks.
11. Press  to scroll through the numbers and then press  when the desired number is shown.
12. Press  to store the capacity value. *d* is displayed.
13. Press  to begin the scale divisions. Press  to scroll through the recommended scale divisions.
14. Press  when the desired scale division is shown and *URLd* will be displayed indicating that the scale is ready for calibration.
15. Follow the standard calibration procedure in Section 5.2 on page 19 (starting with step 2) to calibrate the *MSI-4260*.

## 5.4 Guidelines for Capacity and Resolution

Crane scales are subject to forces that regular floor scales do not see. Many bridge cranes, hoist cranes and mobile cranes lack rigidity and tend to bounce or swing when loads are lifted. For this reason, Rice Lake Weighing Systems recommends that the resolution is kept in the 1:2000 to 1:3000 range. Some improvement in stability can be achieved by increasing the filtering. However, never program the resolution that is far greater than needed. If the *MSI-4260* display is never stable, it is recommended that the resolution is reduced and/or filtering increased.

Due to Legal for Trade requirements and general scale design criteria, the weight must be stable for certain features to work:

- ZERO – the weight must be stable to be zeroed.
- TARE – the weight must be stable to be tared.
- TOTAL – the weight must be stable to be added to the total registers.

One way to improve the stability is to increase the filtering, at the risk of increasing settling time. The other is to increase the *d* (reduce resolution). The third way is to increase the *Motion Window*. The *MSI-4260* defaults to  $\pm 1d$  as a motion window. It can be changed at MSI to a higher value if desired. Often  $\pm 3d$  is chosen for bridge cranes as these tend to have a lot of bounce to them. This of course carries an accuracy penalty adding  $\pm 3d$  to the total accuracy of the scale if the zero or tare operation happens to capture the weight in a valley or peak.

Setting capacity is dictated primarily by the capability of the load cell. Rice Lake Weighing Systems supplies the *MSI-4260* in many capacities.



**Note** *Never set the capacity of the scale higher than the rating of the load cell.*

Due to excellent linearity of the MSI S-Beam load cell, it is acceptable to set lower capacities to better match the crane the *MSI-4260* is used on. For example, if the hoist is rated for 9000 lb, use an MSI 10000 lb and *MSI 4260* and reset the capacity to 9000 lb so that the scale will indicate overload at 9000 lb instead of 10000 lb. Derating as much as 50 percent of the capacity is usually acceptable, but the scale may be less stable if the 'd' is decreased.

Due to kg to lb conversions, the capacity of all *MSI-4260* systems is rated approximately 20 percent higher than the rated capacity in pounds. This is to allow the kg capacity to be exactly 1/2 the number of the pound capacity.

## 5.5 C-Cal Calibration

When adequate test weights are not available, the *MSI-4260* can be calibrated using a programmed constant calibration which is referred to as C-Cal. To use C-Cal, a C-Cal number must be known from a previous calibration. MSI supplies replacement load cells for the *MSI-4260* with the C-Cal value stamped on the serial number label. When a calibration is performed with test weights, a new C-Cal is generated. C-Cal can be used when the electronics are replaced to get an approximate calibration that may be suitable for non L-F-T applications.









### Important



*The C-Cal number must be known prior to starting this procedure. For a MSI-4260 with its original load cell, MSI prints this number on the calibration record, the serial number tag and on the calibration log found inside the battery compartment.*



C-Calibration reduces slightly the absolute accuracy of the system if the electronics are replaced or a new load cell is installed and is intended for non-critical use only. Legal-for-Trade installations require that the *MSI-4260* is calibrated using test weights. If a system was originally multi-point calibrated, the C-CAL calibration will erase the additional span points, as C-Cal is only a two point calibration (zero and span at 10 percent of capacity).

Use the following steps to perform a C-Cal calibration.

1. Remove the hex seal screw from the MS-4260 using the steps from Section 5.1 on page 19.
2. Press  to scroll to the C-Cal menu selection. C-Cal is displayed.
3. Press  to start the C-Cal procedure. UnLd is displayed indicating that all weight should be removed from the hook.
4. Press  to set the zero calibration point. A flashing 0 is displayed.
5. If the zero is in range, the scale will display Pass, then will display CCAL?
6. Press  and the 4260 is ready for numeric entry of the C-Cal value.
7. Press  to enter the C-Cal value. The far left digit will flash indicating that number should be entered.
8. Press  to scroll the numbers and  to enter each digit.



*Example: Enter 2500 kg on a 5000 kg capacity scale.*

*Press  two times for the leftmost blinking digit, press  to save that digit selection.*

*Press  five times for the next blinking digit, press  to save that digit selection.*

*Press  to save that digit selection.*

*Press  to save the next digit selection. 2500 is displayed.*

9. Press  to save the C-Cal value. The display will read *PASS* followed by *CR L d*.
10. Press  to exit C-Cal setup menu and press  again to store the calibration and return to the scale operation and the display will show *5t0rE*.

## 5.6 Calibration Setup Menu

The Calibration Setup Menu contains two additional items beyond Calibration:

- Standard menu
- Auto Zero Maintenance menu (*Auto0*).







In addition, more menus will appear that are transferred from the main setup menu when Legal-for-Trade settings are used.

### 5.6.1 Standard Menu

Selection	Description
Industrial (indu5)	This is the most common setting for the 4260. With the Industrial standard, you have full range zero, access to units switching, filters, and peak hold.
Handbook 44 (Hb-44)	Sets the scale to enable only approved features per the NTEP HB-44 rules and regulations. Access is denied to Peak Hold, and the zero range may be limited. The Filter menu is moved to the Cal Setup Menu, so filters are only accessible through the Cal Seal
R-76 (r-76)	Sets the scale to enable only approved features per OIML R-76. Only kg weight units are available. The zero range is limited to 4% (-1 to +3% relative to Calibrate zero). Net/Gross function is temporary. once Net weight is established, pushing an F key set for Net/Gross will cause a maximum 5 second display of the Gross weight. You must clear the Tare to display Gross weight constantly. Other metrological aspects are changed to meet R-76 requirements.
One Unit (1unit)	The one unit Standard is exactly the same as Industrial, except units switching is inhibited. This is useful for Metric only countries. Another use of the One Unit standard is to allow the scale to be calibrated in units other than lb or kg, since conversions are eliminated. Contact MSI for more information on the Standards settings.

Table 5-1. Standard Menu Selections







Use the following steps to set up a Legal for Trade standard settings.

1. Remove the hex seal screw from the MS-4260 using the steps from Section 5.1 on page 19 and  $\square$  is displayed.
2. Press . *SETUP* is displayed.
3. Press  to enter the Cal setup menu.
4. Press  to enter the standard menu. The current standard setting is displayed.
5. Press  to scroll to the desired standard. *IND* is displayed.
6. Press  to set the standard. *LEGAL* or the next item in the CAL setup menu is displayed.
7. Press  twice to exit setup and store all changes. *STORE* is displayed.

## 5.7 Auto Zero Maintenance

The *MSI-4260* employs an autozeroing maintenance mechanism to adjust the zero reading to the center-of-zero (COZ). COZ is defined as the weight reading is within 1/4 'd' of zero. AZM continuously adjusts zero to maintain COZ. It is recommended that AZM is on to maintain the highest accuracy. However, there are circumstances when it should be turned off. This can happen when minor variations of weight occur while picking up scale attachments and the variations fall within the AZM capture window. The AZM capture window (usually 1 'd') and capture time (usually eight seconds) can be adjusted by MSI to meet custom requirements. The settings of AZM are dictated in Legal-for-Trade standards and cannot be adjusted.

Use the following steps to set up the auto zero maintenance.

1. Remove the hex seal screw from the MS-4260 using the steps from Section 5.1 on page 19 and  $\square$  is displayed.
2. Press . *SETUP* is displayed.
3. Press  to enter the Cal setup menu. *STAND* is displayed.
4. Press  to scroll to the Auto0 menu. *AUTO0* is displayed.
5. Press  to enter the Auto Zero menu. The current setting (blinking) is displayed.
6. Press  to scroll between the on or off key.
7. Press  to set the auto zero. *STAND* is displayed.
8. Press  twice to exit setup and store all changes. *STORE* is displayed.

## 6.0 RF Remote Control Option

### 6.1 Description

*MSI-4260* RF indicators can be equipped with an RF Remote Control (RFRC). The RFRC is a transmit only device that can be used to perform basic scale functions. The default switch functions can be changed in the function key menus and used for any *MSI-4260* programmable functions. The range will vary from 25 feet to 100 feet (50 feet typical) depending on room conditions and line of sight to the display. The remote receiving antenna is behind the red lens of the meter and best range will occur when the display is visible to the operator using the RFRC.

The RFRC provides the ability to turn the *MSI-4260* on remotely. The RFRC is available in three versions differing only in transmit frequency. The standard USA version operates at 418MHz. Available alternative frequencies are 315MHz and 433MHz primarily for use in countries other than the USA.

### 6.2 Functions

The default functions of the RF remote control duplicates the functions of the front panel keys on *MSI-4260* RF indicator. The **POWER**, **ZERO**, **NET/GROSS**, **TARE**, **TOTAL**, and **VIEW** **TOTAL** keys function identically. The **TOTAL** still must be enabled and configured in the *MSI-4260* before the Total features will function properly.

The **F1** key corresponds to the **USER** key on the 4260 front panel. The **F2** key is unique to the remote and the function is set using the Func2 setup menu.

When a successful transmission is achieved, the **ACK** green light will illuminate on the *MSI-4260* front panel.

### 6.3 Setting the Transmitter Address



The MSI RF remote control transmitter allows the selection of one of 16,777,216 (2<sup>24</sup>) unique addresses. All transmitters are supplied pre-configured to the same address. To avoid conflicts with other units or to create unique relationships, the address should be changed. This is accomplished by using a paper clip or probe to press the **CREATE** button on the board through the hole in the back of the case.

1. Press the button and a LED will light up in the **MODE\_IN** window, indicating that the address is being created. The address will be randomized for as long as the button is held down.
2. Release the button and the randomized address will be saved and the LED will begin flashing to indicate that the control permissions may now be set.
3. Press all the buttons one by one that the transmitter will have the authority to access. Press the **CREATE** button with the paper clip again or wait 17 seconds for it to time out. The address and control permissions are now set.





## 6.4 Setting the Receiver Address

Once the transmitter is set up, programming the corresponding *MSI-4260* to match must be done. Use the following steps to set up the receiver address.

1. Program  to *LEARN*. See Section 4.1.1 on page 13. The battery from the *MSI-4260* can also be removed. By doing so the *LEARN* mode will start when the battery is plugged back in.
2. Start *LEARN* by pressing  on the 4260 front panel (or plug in the *MSI-4260* battery).
3. Press each key on the transmitter that is needed to be used. During the *LEARN* process the *ACK* annunciator will blink. All button pushes must be completed during the 17 seconds before the unit times.

Any *MSI-4260* can learn up to seven different remotes. However, never program multiple *MSI-4260*s to the same remote since they will all respond at the same time if they are in range.

### 6.4.1 Resetting the 4260 RF Remote Receiver

1. Program the  to be *LEARN*. See Section 4.1.1 on page 13.
2. Press .
3. Press .
4. Reprogram the scale using the *Setting the Receiver Address* procedure.

## 6.5 Conflict and Jamming Considerations

It is important to understand that only one transmitter at a time can be activated within a reception area. While the transmitted signal consists of encoded digital data, only one carrier of any frequency can occupy airspace without conflict at any given time. This is not to say that there cannot be multiple remote controls for the *MSI-4260*, but rather that two can't be used simultaneously.

The RF remote control is a narrow band low power device and does not have the jamming immunity of the Spread Spectrum Modem used by the *MSI-4260* to communicate to the remote display. Powerful sources of RF energy in the 418MHz region can jam the remote and prevent it from operating. In this circumstance, trying either of the two other available RF remote frequencies (433MHz and 315MHz) might solve the problem. Before ordering the RF remote control option, some effort to research RF devices used in the immediate area would be useful in avoiding jamming the control signals.

It is the end user's responsibility to confirm that the chosen operating frequency is legal for use in the chosen location. 418MHz is legal throughout the USA and Canada. 433MHz is legal in Europe. 315MHz is commonly used for garage door openers and is legal in the USA, but other location legalities have to be investigated.

In spite of the potential for jamming the remote control, the receiver is very immune from false reception due to the 24 bit encoding. Therefore no functions will be inadvertently executed.

## 6.6 Battery Replacement

The remote unit utilizes a CR-2032 button Lithium cell. In normal use it will provide one to two years of operation.

To replace the battery, open the battery access cover by pressing down firmly on the label area and sliding it off. Once the unit is open, remove the battery by sliding it from beneath the holder. Replace the cell with the same type while observing the polarity shown. Once the new battery is installed, both the transmitter and *MSI-4260* will have to learn new addresses. Follow both procedures for setting addresses.

The MSI RF remote has been pre-certified for FCC Part 15 and Industry Canada RSP-100 compliance. The 433.92MHz version has also been tested for CE compliance for use in the European Union. The 315MHz and 418MHz versions are not legal for use in Europe.



## 6.7 RF Remote Control FCC Statement

### Instruction to the User:

This equipment has been tested and found to comply with the limits for a Class B digital device, pursuant to Part 15 of the FCC Rules. These limits are designed to provide reasonable protection against harmful interference in a residential installation. This equipment generates, uses and can radiate radio frequency energy and, if not installed and used in accordance with the instructions, may cause harmful interference to radio communications.

There is no guarantee that interference will not occur in a particular installation. If this equipment does cause harmful interference to radio or television reception, which can be determined by turning the equipment off and on, the user is encouraged to try to correct the interference by one or more of the following measures:

- Reorient or relocate the receiving antenna.
- Increase the separation between the equipment and receiver.
- Connect the equipment into an outlet on a circuit different from that to which the receiver is connected.
- Consult the dealer or an experienced radio/TV technician for help.

This equipment has been certified to comply with the limits for a Class B computing device, pursuant to FCC Rules. In order to maintain compliance with FCC regulations, shielded cables must be used with this equipment. Operation with non-approved equipment or unshielded cables is likely to result in interference to radio and TV reception. The user is cautioned that changes and modifications made to the equipment without the approval of manufacturer could void the user's authority to operate this equipment.



# 7.0 Communications Setup

The *MSI-4260* can communicate with peripheral devices using RS-232, 802.15.4, or 802.11/b,g,n WiFi. Only one communications type can exist at a time. Due to the difficulty of dangling RS-232 cables from a hanging crane scale, the RF options are more commonly used for gathering weight data. The RS-232 port located on the right side of the *MSI-4260* is useful for setup and calibration using a computer and SCCMP Software. (operation is detailed in the SCCMP manual). For RF operation, the *MSI-4260* uses an 802.15.4 transceivers to communicate between Model 8000 RF Remote Display. 802.15.4 operates in the 2.4GHz ISM band and does not require the end user to obtain a license. 802.15.4 can coexist with other 2.4GHz systems if caution is taken to isolate antennas at least 10' (3 M) from the Crane Scales and *MSI-8000* equipment. *MSI-8000* based RF systems are peer to peer. However, for multiple scale connections, the *MSI-8000* acts as the network coordinator. Also available is the 802.11 Wi-Fi option for communicating directly to a standard RF access point. This option is covered by the Wi-Fi for ScaleCore User Guide.

For all devices that must interconnect, the RF Channel and Network ID must match. The ScaleCore ID must be unique. The *MSI-4260* or other RF equipment that is a weight data source should be set to a ScaleCore ID of 0. Then if other slave devices are added, they can be added in sequence.

## 7.1 RF Network Setup

The *MSI-4260* uses 802.15.4 transceivers to communicate with an *MSI-8000* remote display.

The *MSI-4260* uses three numbers to establish a piconet. A piconet is a network that is created using a wireless Bluetooth connection. Table 7-1 lists out the three elements used in setting up a piconet.

Name	Description	Recommended Number Range
ScaleCore ID	This number is used to identify each device in a piconet. Its range is 0-254 and cannot be duplicated within the same RF channel.	20-30
RF Channel	This establishes the base network that all interconnected devices must match.	12-23
Network ID	This is a 64 bit number that all interconnected devices must match. Do not use a small number to avoid other 802.15.4 transeivers that default to a network ID of 0	Maximum of six digits, a range of 0-99999.

 **Note** For all devices that must interconnect, the RF channel and network ID must match. The ScaleCore ID must be unique. The Dyna-Link or crane scale that is the weight source should be set to a ScaleCore ID of 0. Then, if other source devices are added, they can be added in sequence.

Table 7-1. Piconet Setup Ranges

### 7.1.1 802.15.4 RF Network Setup

When equipped with the 802.15.4 option, the *MSI-4260* can connect with an *MSI-8000* Remote Display or an 802.15.4 Modem.



Parameters	Choices	Description
rF	On, Off	Radio Frequency Enable RF – On/Off, affects continuous mode only.
	Sc id	ScaleCore ID – range 0-254, (20-30)
	Chnl	RF Channel – Range 12-23
	Net id	Network ID – Range 0-999999

Table 7-2. RF Menu Parameters

The *MSI-4260* uses three numbers to connect to an 802.15.4 piconet:

















- ScaleCore ID – This number is used to identify each ScaleCore device in a Piconet. It has a range of 0-254 and must not be duplicated within the same RF Channel. For the *MSI-8000* as network coordinator, MSI recommends a number for the *MSI-4260* from 0-3 if multiple units will be connected to the *MSI-8000*. If a single *MSI-4260* is used, then any number up to 254 is acceptable.
- RF Channel – Establishes the base network that all interconnected devices must match. This number must be in the range of 12-23.
- Network ID – This is a 64 bit number that all interconnected devices must match. The *MSI-4260* limits this number to a max of 5 digits for a range of 0-99999. Do not use a small number here to help avoid other 802.15.4 networks that default to a Network ID of 0.

To enter the menu:







1. Press the  and  keys at the same time. *Prnt* displays.









**Note** *busy* may flash momentarily before entering the communications menu.

2. Press . *rF* displays.
3. Press . *On. OFF* displays.
4. Press  to scroll through parameters.
5. Press  to enter parameter. The current value flashes.
6. With parameter displayed, press  to select. The currently selected parameter will flash.
7. Press  to scroll through settings.
8. Press . *Sc id* is displayed.
9. Press . The current ID flashes.
10. Enter the ID using  to scroll through numbers and  to set number.
11. When ID is set, press  again. *Chnl* displays.
12. Press . The current channel flashes.
13. Enter the channel using  to scroll through numbers and  to set number.
14. When channel is set, press  again. *Net id* displays.
15. Enter the network id using  to scroll through numbers and  to set number.
16. When the ID is set, press  again. *On. OFF* displays.
17. Press  twice to save and exit to weighing mode.

## 7.2 Ethernet Setup

1. Press the  and  keys at the same time. *Prnt* displays.
2. Press  to scroll to *Ethnt*.
3. Press . *On. OFF* displays.
4. Press . The current setting flashes.
5. Press  to scroll through settings.

6. With desired setting on display, press .
7. Press . *5c id* is displayed.
8. Press . The current ID flashes.
9. Enter the ID using  to scroll through numbers and  to set number.
10. When ID is set, press  again. *On. OFF* displays.
11. Press  twice to save and exit to weighing mode.

## 7.3 Printer / Serial Output Setup

The RS-232 communications port is capable of outputting load data. All of the RF linked weight device weight modes are available in user formatted form. The control mode program is what controls the *MSI-4260* to print and is described in Section 4.1.1.

The communications port settings are independent of any print settings in connected scales. They reside only in the *MSI-4260*.

### 7.3.1 Control Modes

The user can select four control modes. They are described in Table 7-3.



Mode	Description
User	Printing is controlled by the operator pushing  . Function 1 must be set to print mode. See Section 4.1.9 on page 15
Load	One print occurs when a stable load is read. The scale must then return to near zero before another print will occur.  <b>Note</b> <i>Other configurations of load are available using the ScaleCore Configuration Management Program (ScCMP) application. It can be downloaded from <a href="http://www.ricelake.com">www.ricelake.com</a></i>
Continuous	The <i>MSI-4260</i> will continuously output the data at a rate specified in the rate parameter (up to 65,535 seconds). Setting the interval to 0 will set an interval as fast as the system can go.
Off	Printing is disabled. Power consumption is lower with the print off.

Table 7-3. Control Modes

### 7.3.2 Standard Print Strings

Commands that can be used to format gross, net and print formats are shown below.

Command	Description
<T>	Load data
<U>	Units
<M>	Load mode (lb/kg)
<CRLF>	Carriage return line feed
<SP>	Space

Table 7-4. Standard Print Strings

1	Current load	Fixed output length: 16. Leading zeros suppressed except for the least significant digit (LSD). <TTTTTT><SP><UU><SP><MMMMM><CRLF>
2	Net load	Fixed output length: 16. Leading zeros suppressed except for the LSD. <TTTTTT><SP><UU><SP>NET<SP><SP><CRLF>

Figure 7-1. Standard Print Strings

3	Gross load	Fixed output length: 16. Leading zeros suppressed except for the LSD. <TTTTTT><SP><UU><SP>GROSS><CRLF>
4	Tare Weight	Fixed output length: 16. Leading zeros suppressed except for the LSD. <TTTTTT><SP><UU><SP>TARE><CRLF>
5	Total Weight	Fixed output length: 16. Leading zeros suppressed except for the LSD. <TTTTTT><SP><UU><SP>TTL><CRLF>
6	Number of Samples Totaled	Fixed output length: 16. Leading zeros suppressed except for the LSD. <SP><SP><SP><SP><SP><SP><SSSSSS><SP><T-CNT><SP><CRLF>
7	Current Weight Mode	Net, Gross, Peak, etc <SP><MMMMM><CRLF>
8/9	Carriage Return/ Line Feed.	Used to add a space between print records. <CRLF>

Figure 7-1. Standard Print Strings

Combinations of the standard print strings can be entered in the string number entry screen.

Example: To get a NET, GROSS, TARE printout with a space between records, enter 2349.

The ScCMP application can also be used for custom output strings, see the ScCMP operation manual PN 160274, for details.



**Note** The ScaleCore Configuration Management Program (ScCMP) application can be downloaded from [www.ricelake.com](http://www.ricelake.com).

The serial output is configured as 9600 baud, Xon/Xoff handshaking, no hardware handshaking, 1 stop bit, no parity. Other baud rates are possible by special order only.

### 7.3.3 Printer Output Setup

Use the following steps to set up the printer output.

1. Press and at the same time. *Print* is displayed.
2. Press . *.L 15E0* is displayed.
3. Press . The current setting flashes.
4. Press . *.000E-0* displays.
5. Press . The current setting flashes.
6. Use to toggle between *Port0* and *rF*.
7. When the desired setting is displayed, press . *5E00* displays.
8. Press to enter.
9. Enter the number using to scroll through numbers and to set number.
10. When set, press again. *ENTR* displays.
11. Press to enter. Current setting flashes.
12. Press to scroll through the settings. See Figure 7.3.1.
13. When desired setting is displayed, press . *rAEE* displays.

# 8.0 Troubleshooting/Maintenance

## 8.1 Troubleshooting

Problem	Possible Cause	Solution
The display is blank when the POWER button is depressed	Discharged battery	Recharge the battery. Allow at least four hours charge
	Defective battery	Replace the battery
	Corroded battery or battery contacts	Clean the battery contacts
	Defective switch or circuit board	Requires authorized service
The display does not function properly, the front panel button does not function normally or the scale will not turn off	Improperly updated software	Reinstall the software
	Faulty circuit board	Requires authorized service
	Loose connectors	Requires authorized service
The scale does not respond to weight changes	Out of calibration	Calibrate the unit
	Faulty load cell	Replace the load cell
	Load cell connector	Check the connector and wires
The display over ranges below 100 percent capacity	Tared weight is added to load to determine overload point	Return to gross weight mode
	Zero requires adjustment	Rezero the scale
	Too much weight has been zeroed	Rezero the scale
The display drifts	AZM (Auto0) is turned off	Turn AZM on
	Rapid temperature changes such as moving the scale from indoors to outdoors	Wait until the scale temperature has stabilized
The displayed weight shows a large error	Scale not zeroed before load is lifted	Zero the scale with no load attached
	lb/kg units causing confusion	Select the proper units
	Requires recalibration	Recalibrate the unit
The display reading is not stable	Excessive vibration in crane system	Increase filtering or increase 'd' in Cal
	Excessive side loading	Improve load train symmetry
	Load cell faulty	Check the load cell connections
The display toggles between "Error" and "Load"	Weight exceeds capacity	Reduce weight immediately
	Faulty load cell or wiring	Check load cell and load cell wiring
The display toggles between "Error" and "UnLd"	Weight in below the zero range.	If the scale is in compression, remove the source.
	Calibration faulty	Recalibrate
	Faulty load cell or wiring	Check the load cell connections
The display toggles between "Error" and "A2DLo"	A/D is saturated negative	Check the load cell and load cell wiring
Display toggles between "Error" and "buttn"	A key is stuck or is being held down	Check switches for damage
		Ensure that a remote is not transmitting continuously
RF Remote does not work	Units are not paired	See Section 6.3 and Section 6.4.
Some RF remote keys do not work but the ACK light blinks	The keys were not enabled during the setup process	Enable the keys by running the transmitter and receiver address procedures
Lo Batt is blinking	The battery is low	Recharge the battery
Unit turns on, then immediately turns off	The battery is low	Recharge the battery
Weight will not zero	The system not stable	The stable annunciator must turn on for Zero to function. Increase the filtering for more stability.
		Increase the filtering for more stability
	Zero is out of range	Legal for Trade units have limited zero range. Reduce the weight or use Tare instead

Table 8-1. Troubleshooting

Problem	Possible Cause	Solution
The weight will not Zero, Tare or Total	The system is not stable	Wait for Stable annunciator to turn on, or if in a mechanically noisy crane, increase the filtering or increase the size of the scale increment "d". It is also possible to increase the motion window. Contact MSI if you have a problem getting the MSI-4260 to zero, tare, or total due to stability issues.
Setpoint lights blink	Setpoint is enabled and the trigger point has been reached	Disable set points if they are not needed
Manual total does not work	A Function key is not set to "Total"	Set up Func1 or Func2 for "Total"
	The weight must be stable	Increase filtering for more stability
Auto Total does not work	The weight must be stable	Wait for the stable annunciator to turn on, or Increase filtering for more stability.
	Weight thresholds not reached	You must exceed 1% of capacity for autototal to work. Then you must drop below 0.5% of capacity for additional weighments to register.

Table 8-1. Troubleshooting (Continued)

## 8.2 Service Counters





**WARNING** Only an MSI factory representative can reset the service counters, as these are an important safety warning feature. A thorough load train inspection is necessary to ensure product safety.

The MSI-4260 maintains two service counters for safety.

- The first one counts the number of times the scale has been overloaded.
- The second counter counts lifts above 25% of capacity.

These counters serve to warn the user to inspect the load train after a number of overloads, also when there is a chance of fatigue failure. The power up routine will be interrupted when the lift counter exceeds 16383 lifts or the overload counter exceeds 1023 overloads. If the screen displays  $LFCnE$  when unit is powered on:

1. Press  to display the 25 percent lift counter.
2. Press  again to see the overload lift counter.
3. Press  to acknowledge the warning and return to standard scale operation.



**Note** The power up warning message won't appear again for another 16383 lifts ( or 1023 overloads).

### 8.2.1 Access the Service Counters:

Use the following steps to access the service counters.

4. Program a user function key to be  $EE5E$ . See Section 4.1.2 on page 13.

5. Press .



6. Press . The display flashes

- $LFCnE$  (for Lift Counter) followed by the number of times the weight has exceeded 25% of capacity
- $OLCnE$  (for Overload Counter) followed by the number of times the weight has exceeded capacity
- $C-CAL$  followed by the C-Cal value

Then the display returns to the weigh mode.

To stop the scrolling and step through them slowly proceed to step 7.

7. Press  immediately after  is pressed.

8. Press  to scroll through counters.
9. Press  to enter the counter, the value is displayed.
10. Press  to return to weigh mode.



**WARNING** Only a MSI factory representative can reset the service counters, as these are important safety warning features. Depending on the circumstances, a thorough load train inspection might be necessary to ensure user safety.

Reference MSI's Crane Scale Safety and Periodic Maintenance manual (Pub. 243-08-94D) for proper loading techniques to improve the safety and longevity of your MSI-4260 crane scale. This publication is available at [www.ricelake.com](http://www.ricelake.com) and is included in the CD shipped with your crane scale.



**Note** After the service counters are viewed a few times, the automatic warning stops, but the counters continue to monitor lifts.

### 8.3 MSI-4260 Port-A-Weigh Dimensions

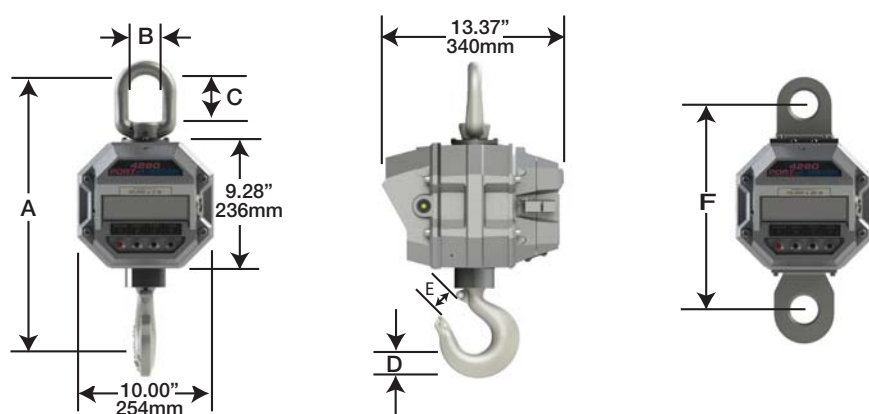

Capacity	Resolution**	A*	B*	C*	D*	E*	F	Hook	Eye Nut or Shackle	Safety Factor	Shipping Wt	
500 lb 250 kg	0.2 lb 0.1 kg	18.3 in 465 mm	2.25 in 57.1 mm	3.06 in 77.7 mm	1.44 in 37.0 mm	1.41 in 36.0 mm	-	5 ton alloy swivel	CR# 7 eyenut	>5	53 lb 24 kg	
2,000 lb 1,000 kg	1 lb 0.5 kg	18.3 in 465 mm	2.25 in 57.1 mm	3.06 in 77.7 mm	1.44 in 37.0 mm	1.41 in 36.0 mm	-	5 ton alloy swivel	CR# 7 eyenut	>5	53 lb 24 kg	
5,000 lb 2,500 kg	1 lb 0.5 kg	20.5 in 521 mm	2.50 in 64.0 mm	3.50 in 89.0 mm	1.81 in 46.0 mm	1.69 in 42.9 mm	-	7 ton alloy swivel	CR#8 eyenut	>5	62 lb 28 kg	
10,000 lb 5,000 kg	2 lb 1 kg	20.5 in 521 mm	2.50 in 64.0 mm	3.50 in 89.0 mm	1.81 in 46.0 mm	1.69 in 42.9 mm	-	7 ton alloy swivel	CR# 8 eyenut	>5	62 lb 28 kg	
20,000 lb 10,000 kg	5 lb 2 kg	28.5 in 724 mm	4.00 in 101.6 mm	6.25 in 159 mm	2.62 in 66.5 mm	2.41 in 61.2 mm	-	15 ton alloy swivel	CR# 11 eyenut	>7 >6.5	105 lb 47 kg	
30,000 lb 15,000 kg	10 lb 5 kg	30.0 in 762 mm	4.00 in 101.6 mm	6.25 in 159 mm	3.00 in 76.2 mm	3.19 in 81.0 mm	-	22 ton alloy swivel	CR# 11 eyenut	>5	125 lb 55 kg	
50,000 lb 25,000 kg	10 lb 5 kg	41.0 in 1041 mm	5.00 in 127 mm	6.00 in 152 mm	3.62 in 92.0 mm	3.63 in 92.0 mm	15.0 in 381 mm	30 ton alloy swivel	CR25ton shackle# 2130	>5 4.9	235 lb 106 kg	
70,000 lb 35,000 kg	20 lb 10 kg	43.2 in 1097 mm	5.00 in 127 mm	6.00 in 152 mm	4.56 in 116 mm	3.75 in 95.0 mm	15.0 in 381 mm	37 ton alloy swivel	CR40ton alloy shackle# 2140	4.75 4.3	270 lb 121 kg	
100,000 lb 50,000 kg	20 lb 10 kg	52.1 in 1324 mm	5.75 in 146 mm	6.65 in 169 mm	5.06 in 129 mm	4.25 in 108 mm	16.25 in 413 mm	45 ton alloy swivel	CR55ton alloy shackle# 2140	4.5 4	420 lb 189 kg	
								Alternate Hooks for 100,000 lb	60 ton alloy swivel	CR55ton alloy shackle# 2140	5 4.5	510 lb 231 kg
									75 ton alloy swivel	CR55ton alloy shackle# 2140	5 4.5	630 lb 286 kg

CR = Crosby or equivalent.

\* These dimensions also apply to 50/70/100000 lb. units with hook and shackle.

\*\* Resolution subject to change for NIST and OIML approved units.

Figure 8-1. 4260 Product Dimensions



# 9.0 Specifications

## Accuracy

$\pm(0.1\% + 1d)$ . d equals one displayable increment.

## Resolution

Standard displayed resolution: 2500-3750'd'.  
Resolutions to 10000 d (non LFT units only) are possible.  
Internal A/D resolution 24 bits

## Standard Capacities

lb 500 2000 5000 10000 20000 30000 50000 70000 100000  
kg 250 1000 2500 5000 10000 15000 25000 35000 50000

## Power

Battery operated, 12V rechargeable sealed lead acid battery pack (standard Port-A-Weigh Charger).  
Up to 100 hours of battery life with Automatic Sleep Mode and Automatic Power Off

## Display

Five digit, large 1.2" (30.5 mm) numeric red GaAlAs Light Emitting Diode (LED)

## Operating Temperature

-40°F to +122°F (-40°C to +50°C), LFT range -10°C to +40°C

## Operating Time

40 hours typical/80 hours max. (depends on brightness of the display and the average number of on segments)

## Enclosure

NEMA Type 4/1P65 powder coated anodized cast aluminum

## Load Cell

Standard 350  $\Omega$  Bridge, MSI Trinocular (>10k lb)

## User

Programmable multifunction button for use as TEST, TOTAL, UNIT, PEAK, NET/GROSS, VIEW TOTAL, LEARN (for RF Remote Control)

## CAL

Wire sealed calibration switch (located on the left side of the front casting).  
Initiates full digital calibration procedure.)

## Auto Zero Maintenance

Standard, can be disabled internally.

## Auto off Mode

Prolongs battery life by turning POWER off after 15, 30, 45 or 60 minutes (operator determined) of no scale activity.

## Auto Sleep Mode

Prolongs battery life by dimming LED display after 5, 15, or 30 minutes of no activity.

## Units

kg, lb (other units available with custom calibrations)

## Filtering

Selectable:

- OFF, Low (LO)
- Medium (HI-1)
- High (HI-2)

## Totalization

Standard: Press button or Automatic; TOTAL weight up to 99999 X 1000 kg/lb

## Peak

Uses unfiltered faster reading of A/D (>400 readings per second)

## Setpoints

Three internal standard setpoints and three ultra bright LEDs on the indicator panel. Contact factory.

## Service Counter

Two independent 32 bit registers;

- Register 1 updated each time weight exceeds 25% of capacity;
- Register 2 updated each time weight exceeds overload;
- When register 1 exceeds 16383 or register 2 exceeds 1023, display reads **LFCnt** for load cell counter; Test function shows the two readings in order

## Construction

All features are housed in heavy duty, cast aluminum housing consisting of three sections:

- The front of the scale houses the display, controls and all electronics
- The center section contains the load cell, lifting eye and hook

The rear of the scale features a quick access battery

## Certifications and Approvals



CoC Number: 88-098A1

Accuracy Class III L  $n_{max} : 5000$







© Rice Lake Weighing Systems Specifications subject to change without notice.  
Rice Lake Weighing Systems is an ISO 9001 registered company.

230 W. Coleman St. • Rice Lake, WI 54868 • USA  
U.S. 800-472-6703 • Canada/Mexico 800-321-6703 • International 715-234-9171 • Europe +31 (0)26 472 1319

---

**[www.ricelake.com](http://www.ricelake.com) [www.ricelake.mx](http://www.ricelake.mx) [www.ricelake.eu](http://www.ricelake.eu) [www.ricelake.co.in](http://www.ricelake.co.in)**

April 28, 2016

PN 152159 Rev C