

# FX-*i* SERIES

FX-120*i*/FX-200*i*/FX-300*i*  
FX-1200*i*/FX-2000*i*/FX-3000*i*

Precision Balance

INSTRUCTION MANUAL



WM+PD4001199

© 2006 A&D Company Ltd. All rights reserved.

No part of this publication may be reproduced, transmitted, transcribed, or translated into any language in any form by any means without the written permission of A&D Company Ltd.

The contents of this manual and the specifications of the instrument covered by this manual are subject to change for improvement without notice.

Windows, Word and Excel are the registered trademarks of the Microsoft Corporation.

# CONTENTS

## Basic Operation

<b>1. INTRODUCTION</b> .....	<b>3</b>
1-1 About This Manual .....	3
1-2 Features .....	3
1-3 Compliance.....	3
<b>2. UNPACKING THE BALANCE</b> .....	<b>4</b>
2-1 Unpacking.....	4
2-2 Installing the Balance .....	5
<b>3. PRECAUTIONS</b> .....	<b>6</b>
3-1 Before Use.....	6
3-2 During Use.....	6
3-3 After Use .....	7
3-4 Power Supply .....	7
3-5 Display Symbols and Key Operation.....	8
<b>4. WEIGHING UNITS</b> .....	<b>9</b>
4-1 Units.....	9
4-2 Storing Units .....	11
<b>5. WEIGHING</b> .....	<b>12</b>
5-1 Basic Operation (Gram Mode) .....	12
5-2 Counting Mode (PCS) .....	13
5-3 Percent Mode (%).....	15
5-4 Statistical Calculation Mode .....	16
5-5 Statistical Calculation Mode (Example of Use) .....	20

## Adapting to the Environment

<b>6. RESPONSE ADJUSTMENT</b> .....	<b>22</b>
<b>7. CALIBRATION</b> .....	<b>23</b>
7-1 Calibration Mode .....	23
7-2 Calibration Using an External Weight.....	24
7-3 Calibration Test Using an External Weight .....	26
<b>8. FUNCTION SWITCH AND INITIALIZATION</b> .....	<b>28</b>
8-1 Permit or Inhibit .....	28
8-2 Initializing the Balance.....	29

## Functions

<b>9. FUNCTION TABLE</b> .....	<b>30</b>
--------------------------------	-----------

9-1 Structure and Sequence of the Function Table .....	30
9-2 Display and Keys .....	30
9-3 Details of the Function Table .....	31
9-4 Description of the Class “Environment, Display” .....	34
9-5 Description of the Item “Data Output Mode” .....	36
9-6 Description of the Item “Data Format” .....	37
9-7 Data Format Examples .....	39
9-8 Description of the Item “Application Function” .....	40
9-9 Comparator Function .....	41
<b>10. ID NUMBER AND GLP REPORT .....</b>	<b>42</b>
10-1 Setting the ID Number .....	42
10-2 GLP Report .....	42
<b>11. UNDERHOOK .....</b>	<b>45</b>
<b>12. PROGRAMMABLE-UNIT .....</b>	<b>46</b>
<b>RS-232C Serial Interface</b>	
<b>13. RS-232C SERIAL INTERFACE .....</b>	<b>47</b>
<b>14. CONNECTION TO PERIPHERAL EQUIPMENT .....</b>	<b>48</b>
14-1 Connection to the AD-8121B Printer .....	48
14-2 Connection to a Computer .....	49
14-3 Using Windows Communication Tools (WinCT) .....	49
<b>15. COMMANDS .....</b>	<b>51</b>
15-1 Command List .....	51
15-2 Acknowledge Code and Error Codes .....	52
15-3 Settings Related to RS-232C .....	53
<b>Maintenance</b>	
<b>16. MAINTENANCE .....</b>	<b>54</b>
<b>17. TROUBLESHOOTING .....</b>	<b>55</b>
17-1 Checking the Balance Performance and Environment .....	55
17-2 Error Codes .....	56
17-3 Asking For Repair .....	57
<b>18. OPTIONS .....</b>	<b>58</b>
<b>19. SPECIFICATIONS .....</b>	<b>60</b>
<b>20. EXTERNAL DIMENSIONS .....</b>	<b>61</b>
<b>21. TERMS/INDEX .....</b>	<b>62</b>

# 1. INTRODUCTION

This manual describes how the FX-*i* series balance works and how to get the most out of it in terms of performance.

Read this manual thoroughly before using the balance and keep it at hand for future reference.

## 1-1 About This Manual

---

This manual consists of the following five parts:

- Basic operation ..... Describes precautions on handling the balance, balance construction and basic balance operation.
- Adapting to the environment.... Describes response adjustment and calibration.
- Functions ..... Describes various functions of the balance.
- RS-232C serial interface..... Describes the interface which transmits data and controls the balance.
- Maintenance ..... Describes maintenance, error codes, troubleshooting, specifications and options.

## 1-2 Features

---

- Compact general-purpose balance, can be installed almost anywhere.
- Casing construction, strong protection against dust and moisture.
- Stabilization time of one second. When **FAST** is selected for the response rate, a stabilization time of one second, to read a displayed value after a sample is placed on the pan, has been achieved.
- Multiple weighing units with most of the common units used around the world.
- Standard RS-232C serial interface to communicate with a computer and to output the Good Laboratory Practice (GLP) data
- Statistical calculation mode to statistically calculate the weight data, and display or output the sum, maximum, minimum, range (maximum-minimum), average, standard deviation and coefficient of variation.
- Comparator Indicators, displaying the comparison results.
- Hold Function, provided for weighing a moving object such as an animal.
- Breeze break, provided for the FX-120*i*/200*i*/300*i*, for more accurate weighing.
- Underhook, provided for suspended weighing.
- As options, the USB interface (FX*i*-02), the Ethernet interface (FX*i*-08) and the built-in battery unit (FX*i*-09) are available.

## 1-3 Compliance

---

### Compliance with FCC Rules

Please note that this device generates, uses and can radiate radio frequency energy. This device has been tested and has been found to comply with the limits of a Class A computing device pursuant to Subpart J of Part 15 of FCC rules. These rules are designed to provide reasonable protection against interference when this device is operated in a commercial environment. If this unit is operated in a residential area, it may cause some interference and under these circumstances the user would be required to take, at his own expense, whatever measures are necessary to eliminate the interference.

(FCC = Federal Communications Commission in the U.S.A.)

# 2. UNPACKING THE BALANCE

## 2-1 Unpacking

- The balance is a precision instrument. Unpack the balance carefully. Keep the packing material to be used for transporting the balance in the future.
- The packing contents depend on the balance model. See the illustrations to confirm that everything is contained.

### How to assemble the breeze break (Only for FX-120i/200i/300i)

Assemble the breeze break as shown below.  
Follow the numbered sequence.

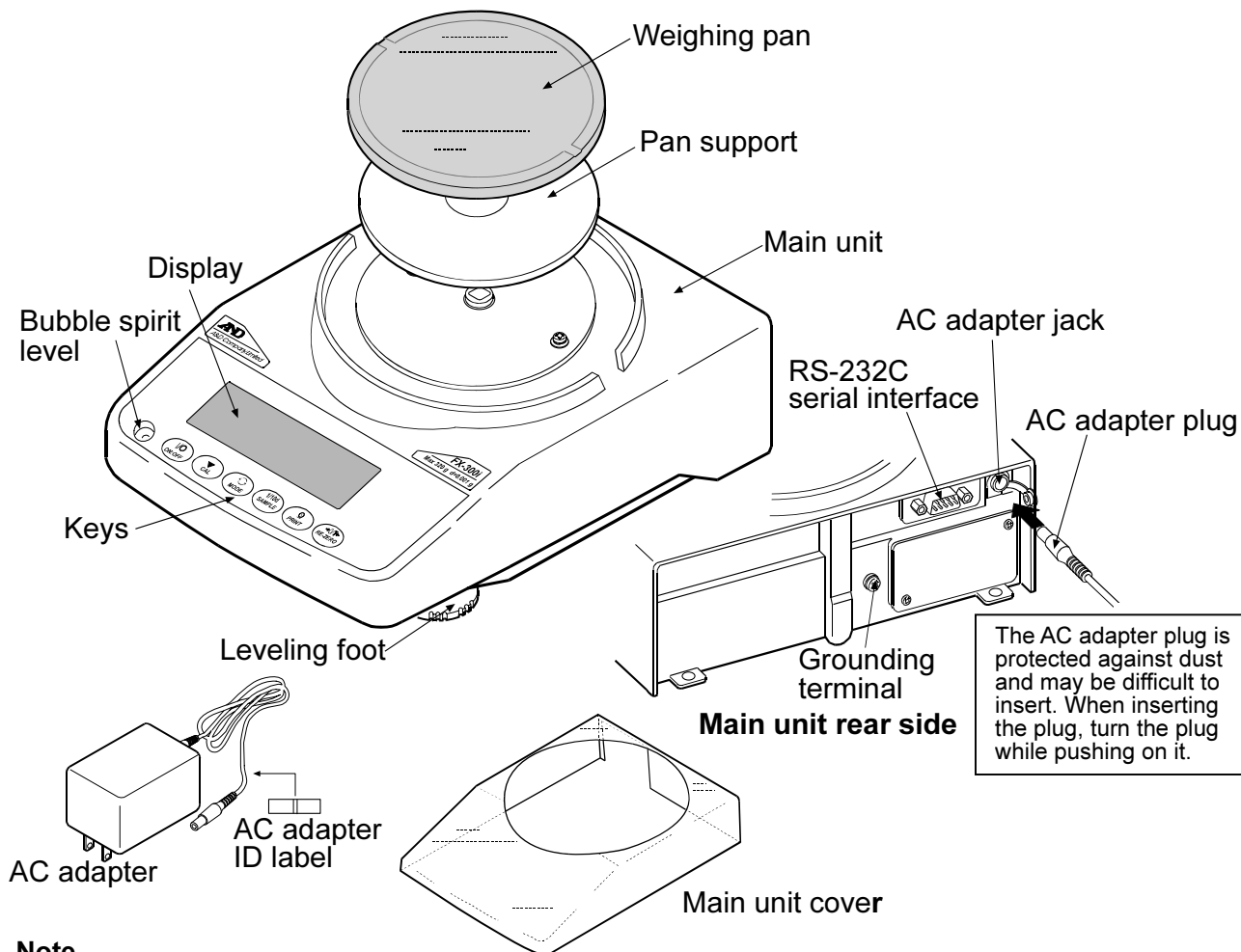
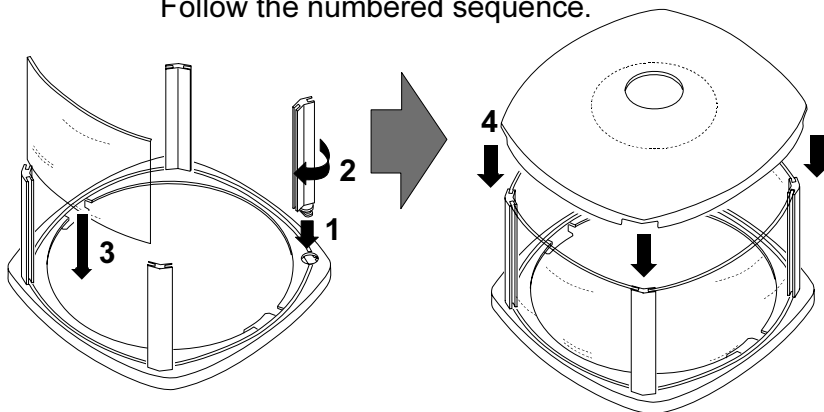

### Note

Please confirm that the AC adapter type is correct for your local voltage and receptacle type.

## 2-2 Installing the Balance

---

Install the balance as follows:

1. Place the balance on a solid weighing table. Refer to “3. PRECAUTIONS” for installing the balance.
2. *FX-120i /200i /300i*  
Assemble the pan support, weighing pan and breeze break, on the balance as shown in the illustration on page 4.  
*FX-1200i /2000i /3000i*  
Assemble the pan support and weighing pan on the balance as shown in the illustration on page 4.
3. Adjust the leveling feet to level the balance. Confirm it using the bubble spirit level.
4. Confirm that the AC adapter type is correct for the local voltage and power receptacle type.
5. Connect the AC adapter to the balance. Warm up the balance for at least 30 minutes with nothing on the weighing pan.

### **Note**

**The AC adapter plug is protected against dust and may be difficult to insert. When inserting the plug, turn the plug while pushing on it.**

## 3. PRECAUTIONS

To get the optimum performance from the balance and acquire accurate weight data, note the following:

### 3-1 Before Use

- Install the balance in an environment where the temperature and humidity are not excessive. The best operating temperature is about 20°C / 68°F at about 50% relative humidity.
- Install the balance where it is not exposed to direct sunlight and it is not affected by heaters or air conditioners.
- Install the balance where it is free of dust.
- Install the balance away from equipment which produces magnetic fields.
- Install the balance in a stable place avoiding vibration and shock. Corners of rooms on the first floor are best, as they are less prone to vibration.
- The weighing table should be solid and free from vibration, drafts and as level as possible.
- Level the balance by adjusting the leveling feet and confirm it using the bubble spirit level.
- Ensure a stable power source when using the AC adapter.
- Plug in the AC adapter and warm up the balance for at least 30 minutes.
- Calibrate the balance before use or after having moved it to another location.

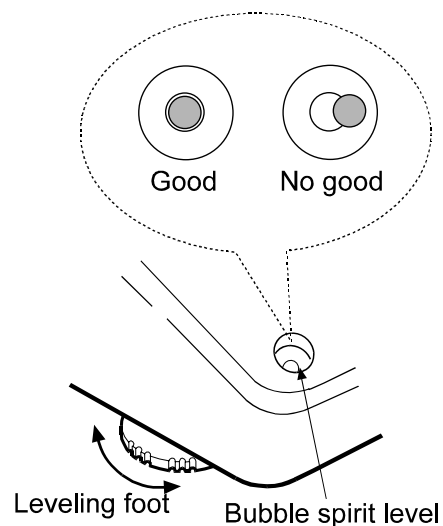

### Caution

**Do not install the balance where flammable or corrosive gas is present.**

### 3-2 During Use

- Discharge static electricity from the material to be weighed (hereinafter referred to as the sample). When a sample could have a static charge, the weight data is influenced. Ground the balance and try the following:
  - Eliminate static electricity using the optional AD-1683 DC static eliminator.
  - Try to keep the ambient humidity above 45%RH.
  - Use a metal shield case for a charged sample.
  - Wipe charged plastic samples with a moistened cloth.

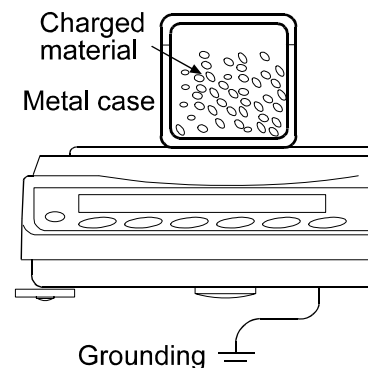



- This balance uses a strong magnet as part of the balance assembly, so please use caution when weighing magnetic materials such as iron. If there is a problem, use the underhook on the bottom of the balance to suspend the material away from the influence of the magnet.

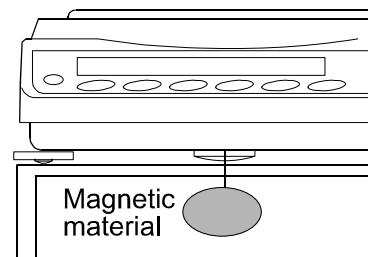

- Eliminate the temperature difference between a sample and the environment. When a sample is warmer (cooler) than the ambient temperature, the sample will be lighter (heavier) than the true weight. This error is due to a rising (falling) draft around the sample.
- Make each weighing gently and quickly to avoid errors caused by the evaporation of moisture from the sample or the absorption of moisture by the sample.
- Do not drop things upon the weighing pan, or place a sample on the pan that is beyond the balance weighing capacity. Place a sample in the center of the weighing pan.
- Do not use a sharp instrument such as a pencil to press the keys. Use your finger only.
- Press the **RE-ZERO** key before each weighing to eliminate possible errors.
- Calibrate the balance periodically so as to eliminate possible errors.
- Take into consideration the affect of air buoyancy on a sample when more accuracy is required.
- Keep the balance interior free of dust and foreign materials.
- The breeze break (FX-120i /200i /300i only) is provided as an accessory. An anti-static treatment has been applied to the breeze break components, but they may be charged with static electricity when they are unpacked or when the humidity is low. If the weight value is unstable even when there are no drafts or the balance has a problem with repeatability, remove the breeze break. Or wipe the clear plates with a moistened cloth, use the optional AD-1683 DC static eliminator or apply an anti-static spray.

### 3-3 After Use

---

- Avoid mechanical shock to the balance.
- Do not disassemble the balance. Contact the local A&D dealer if the balance needs service or repair.
- Do not use organic solvents to clean the balance. Clean the balance with a lint free cloth that is moistened with warm water and a mild detergent.
- The edge of the weighing pan is sharp. Use much care when cleaning the pan.
- Avoid dust and water so that the balance weighs correctly. Protect the internal parts from liquid spills and excessive dust.

### 3-4 Power Supply

---

- When the AC adapter is connected, the balance is in the standby mode if the standby indicator is on (refer to “3-5 Display Symbols and Key Operation”). This is a normal state and does not harm the balance. For accurate weighing, warm up the balance for at least 30 minutes before use.

## 3-5 Display Symbols and Key Operation

### Key operation

Key operation affects how the balance functions. The basic key operations are:

- “Press and release the key immediately” or “Press the key”  
= normal key operation during measurement
- “Press and hold the key”

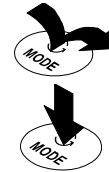





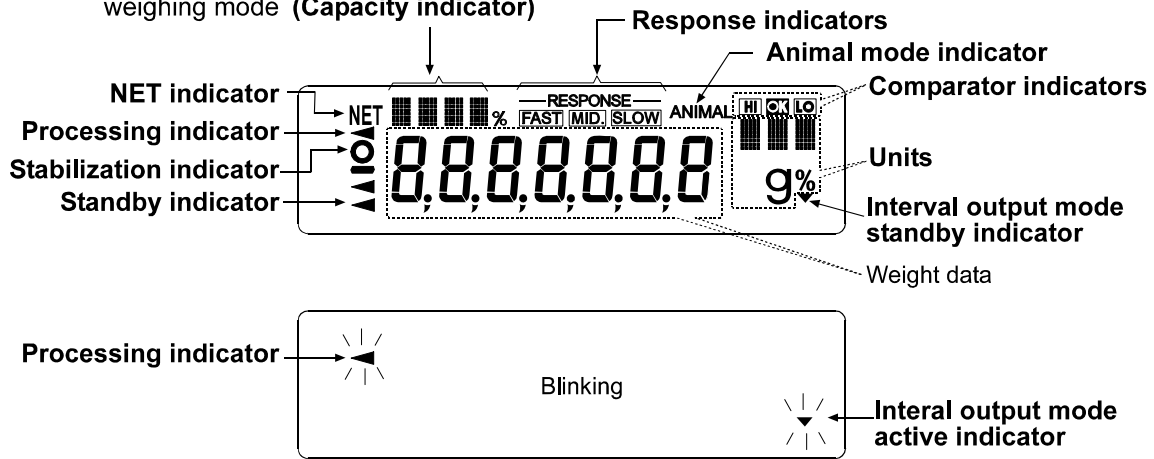

### Display symbols

- Number of statistical data (Statistical calculation mode)
- Displays the weight data relative to the weighing capacity, in percentage, in the weighing mode (**Capacity indicator**)



Each key, when pressed or when pressed and held, functions as follows:

Key	When pressed	When pressed and held
	Turns the display on or off. The standby indicator is displayed when the display is turned off. The weighing mode is enabled when the display is turned on. This key is available anytime. Pressing the key during operation will interrupt the operation and turn the display off.	
	In the weighing mode, turns the minimum weighing value on or off. In the counting or percent mode, enters the sample storing mode.	Enters the function table mode. Refer to “9. FUNCTION TABLE”.
	Switches the weighing units stored in the function table. Refer to “4. WEIGHING UNITS”.	Enters the response adjustment mode.
	Cancels the operation when performing settings.	Enters the calibration mode.
	Outputs the weight data to a printer or personal computer using the RS-232C serial interface, depending on the function table settings. Confirms the operation when performing settings.	No function at the factory setting By changing the function table: Outputs “Title block” and “End block” for GLP report.
	Sets the display to zero.	

# 4. WEIGHING UNITS

## 4-1 Units

With the FX-i series balance, the following weighing units and weighing modes are available:

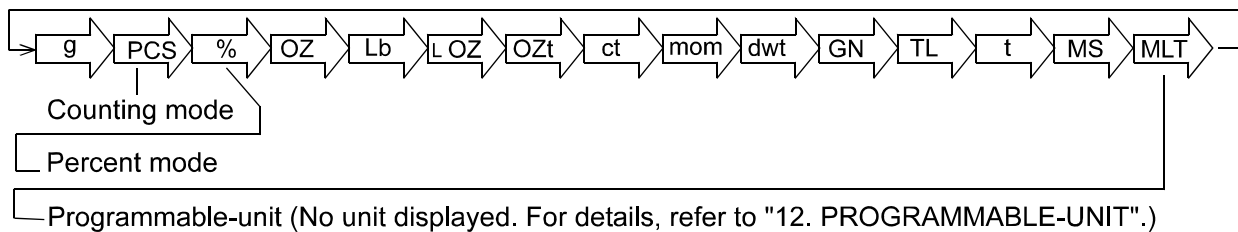

A unit or mode can be selected and stored in the function table as described on page 11. If a weighing mode (or unit of weight) has been turned off, that mode or unit will be missing in the sequence. Tael has four varieties, one of which can be selected and installed at the factory.

To select a unit or mode for weighing, press the **MODE** key.

For details about the units and modes, see the table below:

Name (unit, mode)	Abbrev.	Display	Function table (Storing mode)	Conversion factor 1 g =
Gram	g	g	g	1 g
Counting mode	pcs	PCS	PCS	—
Percent mode	%	%	%	—
Ounce (Avoir)	oz	oz	oz	28.349523125 g
Pound	lb	lb	lb	453.59237 g
Pound/Ounce	L OZ	L oz	LO	1Lb=16 oz, 1 oz=28.349523125 g
Troy Ounce	OZt	ozt	ozt	31.1034768 g
Metric Carat	ct	ct	ct	0.2 g
Momme	mom	mom	mom	3.75 g
Pennyweight	dwt	dwt	dwt	1.55517384 g
Grain (UK)	GN	GN	GN	0.06479891 g
Tael (HK general, Singapore)	TL	tl	tl	37.7994 g
Tael (HK jewelry)				37.429 g
Tael (Taiwan)				37.5 g
Tael (China)				31.25 g
Tola (India)	tol	tol	tol	11.6638038 g
Messghal	mes	mes	mes	4.6875 g
Programmable-unit (Multi-unit)	Mlt	MLT	MLT	—

The tables below indicate the weighing capacity and the minimum display for each unit, depending on the balance model.

Unit	Capacity			Minimum display
	FX-120 <i>i</i>	FX-200 <i>i</i>	FX-300 <i>i</i>	
Gram	122.000	220.000	320.000	0.001
Ounce (Avoir)	4.30340	7.76025	11.28765	0.00005
Pound	0.268965	0.485015	0.705480	0.000005
Pound/Ounce	0L 4.30oz	0L 7.76oz	0L 11.29oz	1L 0.01oz
Troy Ounce	3.92240	7.07315	10.28825	0.00005
Metric Carat	610.000	1100.000	1600.000	0.005
Momme	32.2535	58.6665	85.3335	0.0005
Pennyweight	78.621	141.776	206.220	0.001
Grain (UK)	1882.74	3395.12	4938.34	0.02
Tael (HK general, Singapore)	3.22755	5.82020	8.46575	0.00005
Tael (HK jewelry)	3.25950	5.87780	8.54950	0.00005
Tael (Taiwan)	3.25330	5.86670	8.53330	0.00005
Tael (China)	3.90400	7.04000	10.24000	0.00005
Tola (India)	10.4597	18.8618	27.4353	0.0001
Messghal	26.0265	46.9335	68.2665	0.0005

Unit	Capacity			Minimum display
	FX-1200 <i>i</i>	FX-2000 <i>i</i>	FX-3000 <i>i</i>	
Gram	1220.00	2200.00	3200.00	0.01
Ounce (Avoir)	43.0340	77.6025	112.8765	0.0005
Pound	2.68965	4.85015	7.05480	0.00005
Pound/Ounce	2L 11.03oz	4L 13.60oz	7L 0.88oz	1L 0.01oz
Troy Ounce	39.2240	70.7315	102.8825	0.0005
Metric Carat	6100.00	11000.00	16000.00	0.05
Momme	322.535	586.665	853.335	0.005
Pennyweight	786.21	1417.76	2062.20	0.01
Grain (UK)	18827.4	33951.2	49383.4	0.2
Tael (HK general, Singapore)	32.2755	58.2020	84.6575	0.0005
Tael (HK jewelry)	32.5950	58.7780	85.4950	0.0005
Tael (Taiwan)	32.5330	58.6670	85.3330	0.0005
Tael (China)	39.0400	70.4000	102.4000	0.0005
Tola (India)	104.597	188.618	274.353	0.001
Messghal	260.265	469.335	682.665	0.005

## 4-2 Storing Units

The units or modes can be selected and stored in the function table. The sequence of displaying the units or modes can be arranged in the function table so as to fit the frequency of use.

Select a unit or mode and arrange the sequence of display as follows:

- 1 Press and hold the **SAMPLE** key until **bRSFnC** of the function table is displayed.
- 2 Press the **SAMPLE** key several times to display **Unit**.
- 3 Press the **PRINT** key to enter the unit selection mode.
- 4 Specify a unit or mode in the order to be displayed using the following keys.  

<b>SAMPLE</b> key	To sequentially display the units.
<b>RE-ZERO</b> key	To specify a unit or mode. The stabilization indicator appears when the displayed unit or mode is specified.
- 5 Press the **PRINT** key to store the units or modes. The balance displays **End** and then displays the next menu of the function table.
- 6 Press the **CAL** key to exit the function table. Then the balance returns to the weighing mode with the unit specified first in step 4.

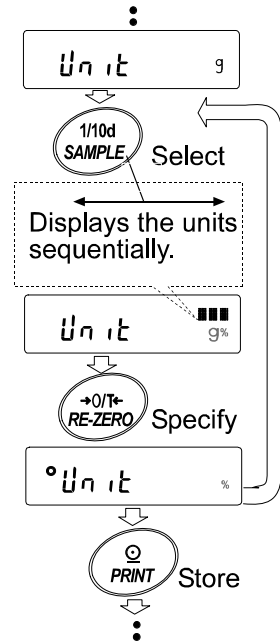

### Notes

**When the power is turned on, the scale displays the unit specified first in step 4.**

**In the weighing mode, to select a unit or mode for weighing, press the **MODE** key.**

# 5. WEIGHING

## 5-1 Basic Operation (Gram Mode)

1 Place a container on the weighing pan, if necessary.  
Press the **RE-ZERO** key to cancel the weight (tare). The balance displays **0.00 g**. (The decimal point position depends on the balance model.)

2 Place a sample on the pan or in the container.

3 Wait for the stabilization indicator to be displayed. Read the value.

While the stabilization indicator is on, pressing the **PRINT** key will output the weight value, using the RS-232C serial interface.

### Note

Peripheral equipment, that is sold separately, such as a printer or a personal computer is required.

4 Remove the sample and container from the pan.

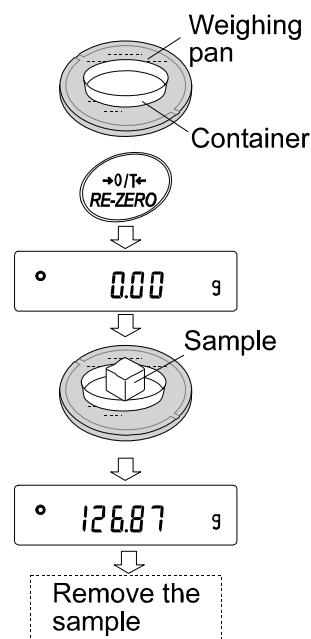

### Notes

To use other units, press the **MODE** key and select an appropriate unit.

Press the **SAMPLE** key to turn on or off the minimum weighing value.

When the **ON:OFF** key is pressed with a container placed on the weighing pan, the balance displays **0.00 g** and weighing is started,

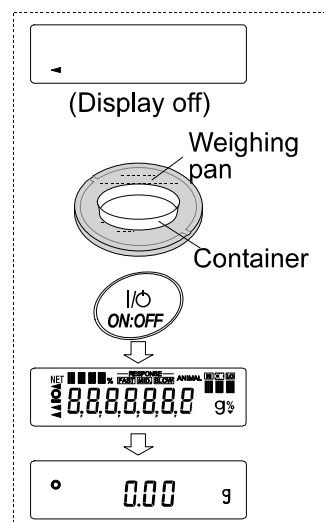

## 5-2 Counting Mode (PCS)

This is the mode to determine the number of objects in a sample based on the standard sample unit mass. Unit mass means the mass of one sample. The smaller the variables in each sample unit mass are, the more accurate the counting will be. The FX-*i* series balance is equipped with the Automatic Counting Accuracy Improvement (ACAI) function to improve the counting accuracy.

### Note

If the sample unit mass variable is too large, it may cause a counting error.

### Selecting the counting mode

- 1 Press the **MODE** key to select **PCS** (counting mode).

### Storing a sample unit mass

- 2 Press the **SAMPLE** key to enter the sample unit mass storing mode.  
Even in the storing mode, pressing the **MODE** key will switch to the next mode.
- 3 To select the number of samples, press the **SAMPLE** key several times. It may be set to 5, 10, 25, 50 or 100.

### Note

A greater number of samples will yield more accurate counting result.

- 4 Place a container on the weighing pan, if necessary. Press the **RE-ZERO** key to cancel the weight (tare). The number specified in step 3 appears.  
e.g.: **25 0** is displayed if 25 is selected in step 3.
- 5 Place the number of samples specified on the pan. In this example, 25 pieces.
- 6 Wait for the stabilization indicator to come on. Press the **PRINT** key to calculate and store the unit mass. The balance displays **25 PCS** (counting mode) and is set to count samples with this unit mass. (The sample unit mass stored, even if the AC adapter is removed, is maintained in non-volatile memory.)

To improve the accuracy of the unit mass, proceed to step 8.

### Notes

If the balance judges that the mass of the samples is too light and is not adequate to be used as the unit mass, it displays **Lo**. In that case, store the mass by some quantity. For example, when the model with the minimum weighing value of 0.01 g is used and 10 pieces of samples weigh 0.05 g. Store 100 pieces of samples as 10 and multiply the weighing result by 10.

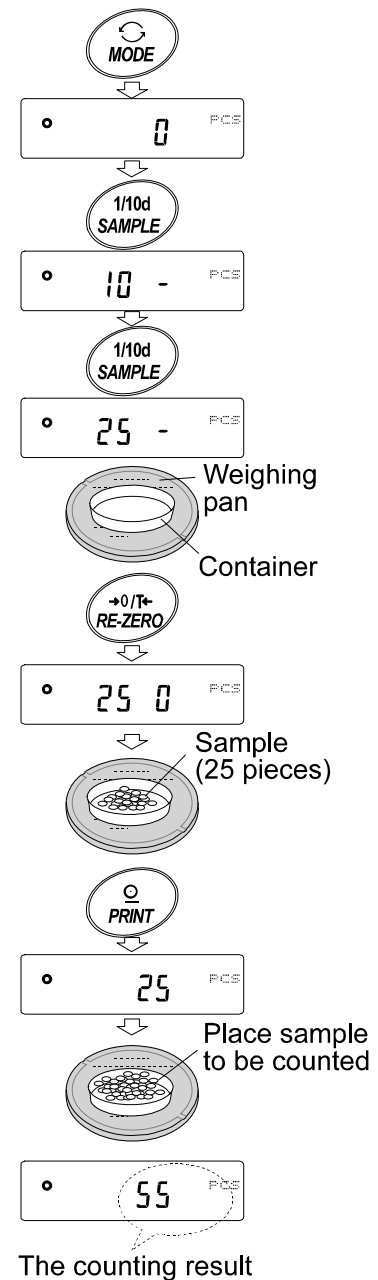

If the balance judges that the mass of the samples is too light to acquire accurate weighing, it displays an error requiring the addition of more samples to the specified number. In the example above, **50-PCS** appears, requiring 25 more samples. Add 25 samples and press the **PRINT** key. When the unit mass is stored correctly, the balance proceeds to the counting mode.

### Counting operation

- Place the samples to be counted on the pan.  
While the stabilization indicator is on, pressing the **PRINT** key will output the weight value, using the RS-232C serial interface.

**Note**

**Peripheral equipment, that is sold separately, such as a printer or a personal computer is required.**

### Counting mode using the ACAI function

The ACAI is a function that improves the accuracy of the unit mass automatically by increasing the number of samples and averaging the unit mass variable to minimize the weighing error, as the counting process proceeds.

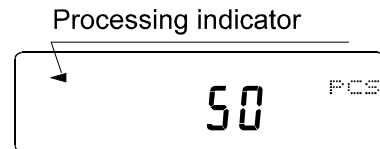

- If a few more samples are added, the processing indicator turns on. To prevent an error, add three or more. The processing indicator does not turn on if overloaded. Try to add the same number of samples as displayed.
- The balance re-calculates the unit mass while the processing indicator is blinking. Do not touch the balance or samples on the pan until the processing indicator turns off.
- Counting accuracy is improved when the processing indicator turns off.  
Each time the above operation is performed, a more accurate unit mass will be obtained. There is no definite upper limit of ACAI range for the number of samples exceeding 100. Try to add the same number of samples as displayed.
- Remove all the samples used in ACAI and proceed with the counting operation using the improved unit mass.



## 5-3 Percent Mode (%)

This is the mode to display the weight value in percentage compared to a 100% reference mass and is used for target weighing or checking the sample variable.

### Selecting the percent mode

- 1 Press the **MODE** key to select **%** (percent mode).

### Storing the 100% reference mass

- 2 Press the **SAMPLE** key to enter the 100% reference mass storing mode.

Even in the storing mode, pressing the **MODE** key will switch to the next mode.

- 3 Place a container on the weighing pan, if necessary. Press the **RE-ZERO** key to cancel the weight (tare). The balance displays **100 0 %**.
- 4 Place the sample to be set as the 100% reference mass on the pan or in the container.

- 5 Press the **PRINT** key to store the reference mass. The balance displays **100.00 %**. (The decimal point position depends on the reference value. The reference mass stored, even if the AC adapter is removed, is maintained in non-volatile memory.)

### Note

If the balance judges that the mass of the sample is too light to be used as a reference, it displays **L0**. Do not use the sample.

- 6 Remove the sample.

### Reading the percentage

- 7 Place a sample to be compared to the reference mass on the pan. The displayed percentage is based on the 100% reference mass.

While the stabilization indicator is on, pressing the **PRINT** key will output the weight value, using the RS-232C serial interface.

### Note

Peripheral equipment, that is sold separately, such as a printer or a personal computer is required.

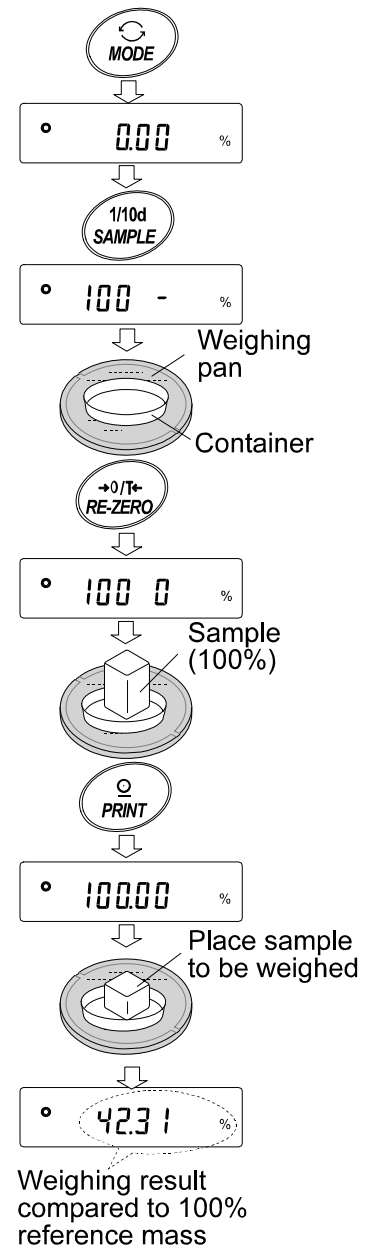

## 5-4 Statistical Calculation Mode

The statistical calculation mode statistically calculates the weight data, and displays or outputs the results. To use the statistical calculation mode, set the "Application function (APF)" parameter of "Application (AP Fnc)" in the function table to "2", as described below.

Statistical items available are number of data, sum, maximum, minimum, range (maximum-minimum), average, standard deviation and coefficient of variation. What statistical items to output can be selected from the three modes in the function table.

- The wrong data input can be canceled by the key operation, if immediately after the input.
- Turning the balance off will delete the statistical data.
- The standard deviation and coefficient of variation are obtained by the equation below:

$$\text{Standard deviation} = \sqrt{\frac{N \cdot \sum (X_i)^2 - (\sum X_i)^2}{N \cdot (N-1)}} \quad \text{where } X_i \text{ is the } i\text{-th weight data,}$$

N is number of data.

$$\text{Coefficient of variation (CV)} = \frac{\text{Standard deviation}}{\text{Average}} \times 100 (\%)$$

### 5-4-1 Getting Started

#### Switching to the Statistical Function Mode (Changing The Function Table)

- 1 Press and hold the **SAMPLE** key until **bAS5Fnc** of the function table is displayed, then release the key.
- 2 Press the **SAMPLE** key several times to display **AP Fnc**.
- 3 Press the **PRINT** key to display **APF 0**.
- 4 Press the **RE-ZERO** key to display **APF 2**.

To select statistical items to output, go to step 5.

To store the statistical function mode setting, go to step 7.

To disable the statistical calculation mode, press the **RE-ZERO** key to select **APF 0**.

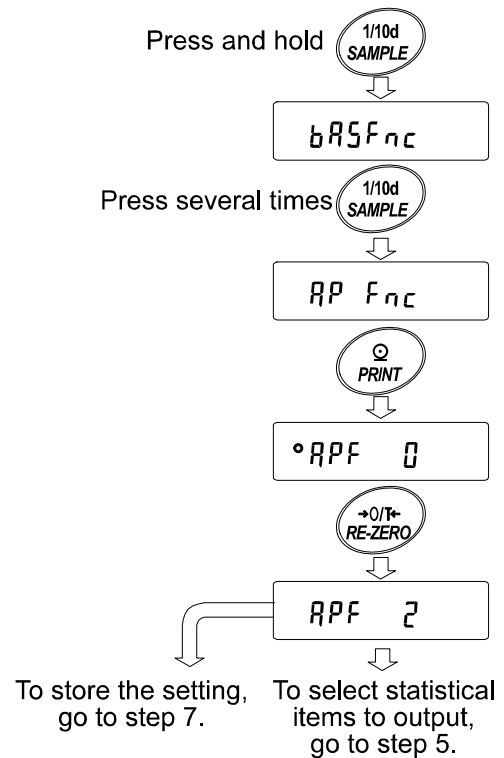

## Selecting the statistical items to output

5 Press the **SAMPLE** key to display **STAT 0**.

6 Press the **RE-ZERO** key to select the output items.

In the example, **STAT 1** is selected to output the number of data, sum, maximum, minimum, range (maximum – minimum) and average.

Parameter	Description
0	Number of data, sum
1	Number of data, sum Maximum, minimum, range (maximum – minimum), average
2	Number of data, sum Maximum, minimum, range (maximum – minimum), average, Standard deviation, coefficient of variation

7 Press the **PRINT** key to store the setting.

### Note

The statistical calculation mode will be enabled using the **ON:OFF** key or when the power is turned on.

8 Press the **CAL** key to return to the weighing mode.

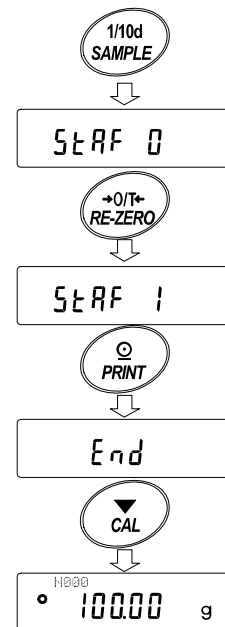

## Selecting the unit

9 Press the **MODE** key to select the unit to be used for the statistical calculation mode.

### Notes

Selecting the unit using the **MODE** key is not available after the data is entered. In this case, clear the data as described on page 19 and select the unit using the **MODE** key.

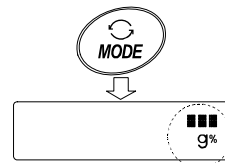

When the statistical calculation mode is to be enabled upon power-on, select the unit in “Unit (Unit)” of the function table beforehand.

## 5-4-2 Using The Statistical Calculation Mode

### Entering data for statistical calculation

Use the following keys to operate the statistical calculation mode.

- MODE** key .....
  - When the data is entered, moves between the displaying items (weighing mode, statistical results and data operation) each time the key is pressed.
  - When no data has been entered, selects the unit.
- SAMPLE** key ..... Turns the minimum display on or off, in the weighing mode.
- RE-ZERO** key ..... Sets the display to zero in the weighing mode.
- PRINT** key .....
  - Outputs the data number and the weight data and includes the weight data to statistical calculation in the weighing mode. (Output is not in the data format specified in the function table because of the data number added.)
  - Outputs the statistical results while the statistical results are displayed. (Output is not in the data format specified in the function table.)
- CAL** key ..... Returns to the weighing mode.

- 1 Press the **RE-ZERO** key to set the display to zero.
- 2 Place the sample on the weighing pan and wait for the stabilization indicator to turn on.
- 3 Press the **PRINT** key to add the data displayed to statistical calculation. The number of data on the upper left of the display increases by 1.
- 4 Repeat steps 1 to 3 for each weighing.

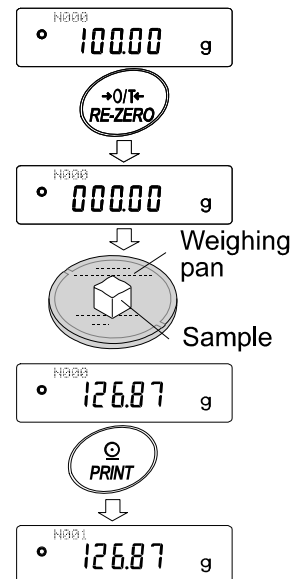

### Outputting the statistical results

- 5 Each time the **MODE** key is pressed, the display changes: the results as selected in "Statistical function mode output items (SetAF)", **CANCEL** and **CLEAR**.

#### Notes

When the number of data is 1, the standard deviation and coefficient of variation are displayed as **-----**.

When the average is 0, the coefficient of variation is displayed as **-----**.

Statistical items are indicated on the upper left of the display using the following symbols.

Symbol	Statistical item
SUM	Sum
MAX	Maximum
MIN	Minimum
R	Range (Maximum – minimum)
AVE	Average
SD	Standard deviation
CV	Coefficient of variation

- 6 While the results are displayed, press the **PRINT** key to output the results.

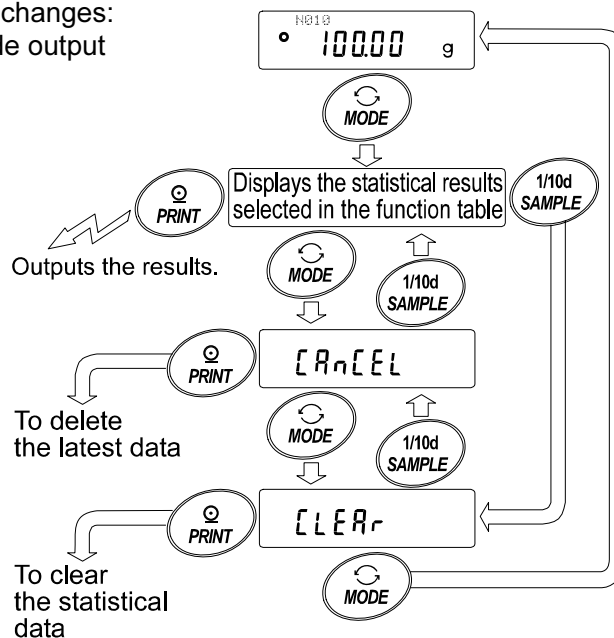

### Output example

		Function table parameter
No.	10	0
TOTAL	100.00 g	
MAX	10.50 g	1
MIN	9.50 g	
AVE	10.00 g	2
R	1.00 g	
SD	0.280 g	
CV	2.80 %	

## Deleting the latest data

When the wrong data is entered, it can be deleted and excluded from statistical calculation. Only the latest data can be deleted.

- 1 In the weighing mode, press the **MODE** key, and then press the **SAMPLE** key several times to display **[RnCEL]**.
- 2 Press the **PRINT** key to display **[Rn n0]**.
- 3 Press the **RE-ZERO** key to display **[Rn 00]**.
- 4 Press the **PRINT** key to delete the latest data and exclude it from statistical calculation. The number of data decreases by 1 when the balance returns to the weighing mode.

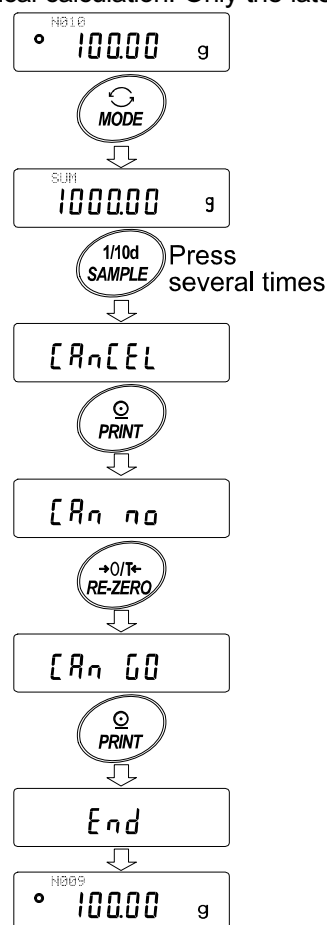

## Clearing the statistical data

All the statistical data will be deleted and the number of data will be 0 (zero).

- 1 In the weighing mode, press the **MODE** key, and then press the **SAMPLE** key several times to display **[CLEARr]**.
- 2 Press the **PRINT** key to display **[Lr n0]**.
- 3 Press the **RE-ZERO** key to display **[Lr 00]**.
- 4 Press the **PRINT** key to delete the statistical data. The number of data becomes 0 (zero) when the balance returns to the weighing mode.

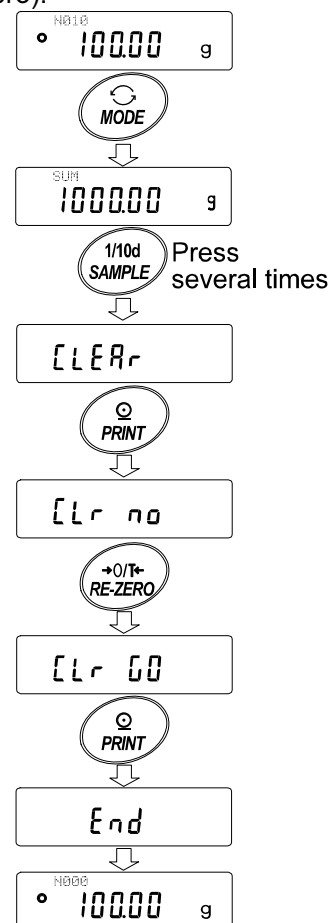

## 5-5 Statistical Calculation Mode (Example of Use)

Here, as an example of use of the statistical calculation mode, mixing of the multiple formulae such as medicine is described. The mixing process is recorded using the balance and the printer. In the example, the FX-3000i and the AD-8121B (dump print mode) are connected using the RS-232C serial interface.

### 5-5-1 Getting Started

#### Changing the function table

- Changes:
- To enable the statistical calculation mode
  - To enable “Zero after output”

#### Enabling the statistical calculation mode

- Enter the function table menu.  
Press and hold the **SAMPLE** key until **bRSFnC** of the function table is displayed, then release the key.
- Select the application function.  
Press the **SAMPLE** key several times to display **RP Fnc**. Then, press the **PRINT** key to display **°RPF 0**.
- Change the application function parameter to “2”.  
Press the **RE-ZERO** key to display **RPF 2**. Press the **PRINT** key to confirm the change. After **End**, **bRSFnC** is displayed.

#### Enabling “Zero after output”

- Select “Zero after output”.  
Press the **SAMPLE** key several times to display **dout**. Then, press the **PRINT** key to display **°Pr t 0**, and press the **SAMPLE** key several times to display **°Rr-d 0**.
- Enable “Zero after output”.  
Press the **RE-ZERO** key to display **Rr-d 1**. Then, press the **PRINT** key to confirm the change. After **End**, **S,F** is displayed.

#### Returning to the weighing mode

- Press the **CAL** key to return to the weighing mode.

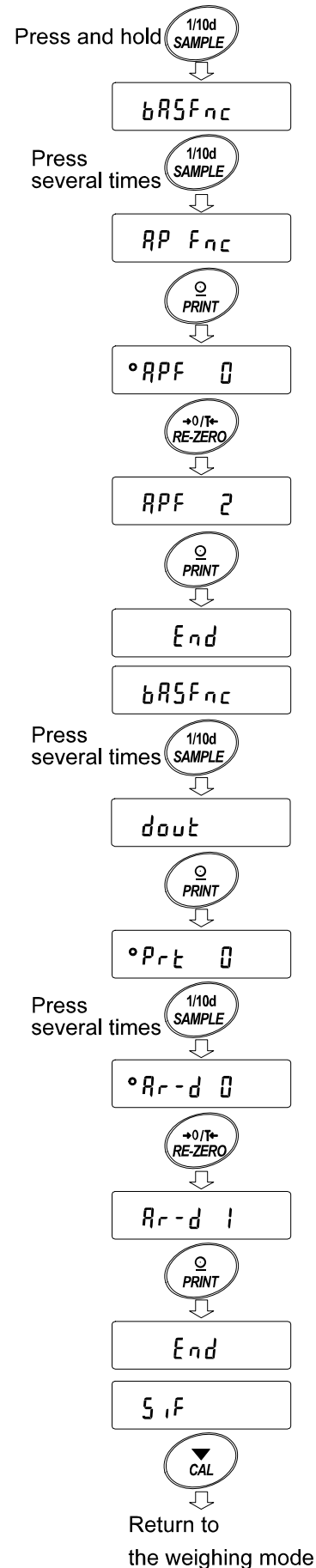

## 5-5-2 Using The Statistical Calculation Mode

- 1 Press the **RE-ZERO** key to set the display to zero.
- 2 Place a container on the weighing pan.  
Press the **PRINT** key to cancel the weight (tare). The balance displays **0.00 g**. (Storing the tare value)  
The tare value data is output when the peripheral output equipment is connected.
- 3 Weigh formula 1 and press the **PRINT** key. The balance displays **0.00 g**. (Storing the weight value of formula 1)  
The weight value data is output when the peripheral output equipment is connected.
- 4 Weigh formula 2 and press the **PRINT** key. The balance displays **0.00 g**. (Storing the weight value of formula 2)  
The weight value data is output when the peripheral output equipment is connected.
- 5 When there are some more formulae to be added, repeat step 4.
- 6 After mixing is complete, press the **MODE** key to display the statistical results.
- 7 Press the **PRINT** key to output the number of data saved including the tare value and the total weight.

### Output example

No. 1		
ST, +00005.63	g	.....Tare value
No. 2		
ST, +00001.99	g	.....Formula 1
No. 3		
ST, +00007.78	g	.....Formula 2
N	3	
SUM	+15.40	g .....Total weight

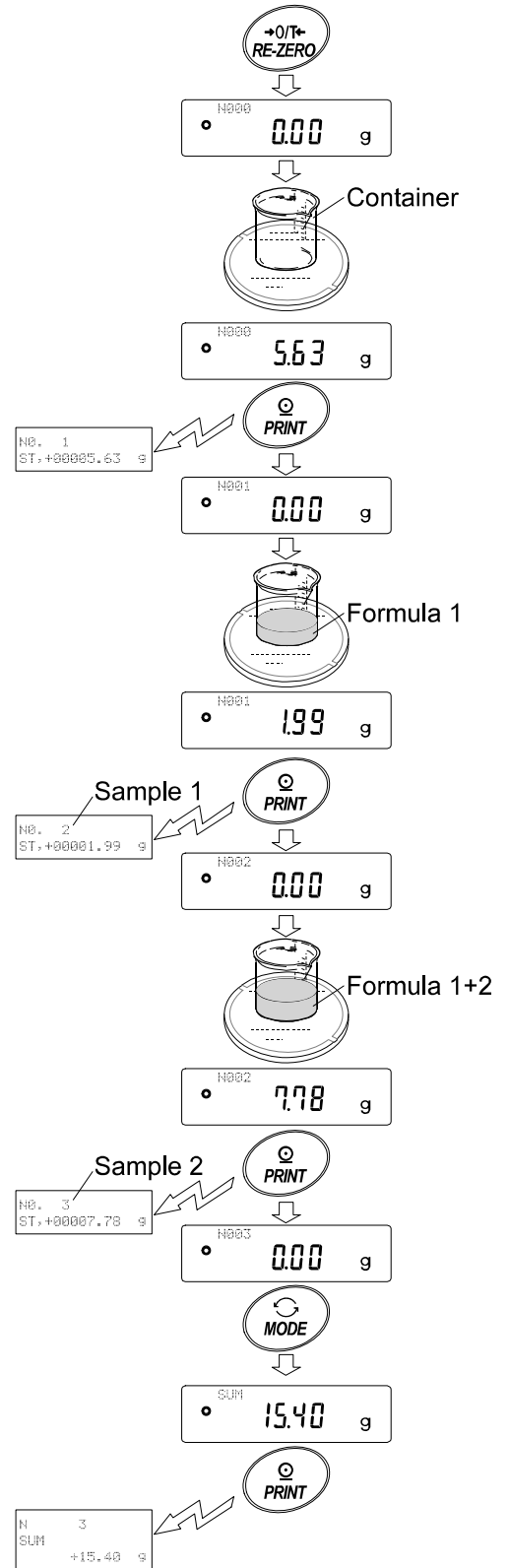

## 6. RESPONSE ADJUSTMENT

This function stabilizes the weight value, reducing the influence on weighing that is caused by drafts and vibration at the place where the balance is installed.

The function has three stages as follows and can be changed by simple key operation.

Indicator	Description
FAST	Fast response, but prone to drafts and vibration. Good for target weighing.
MID.	
SLOW	Slow response, but strong against drafts and vibration Good for weighing which requires a stable display.

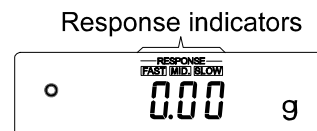

### Operation

- 1 Press and hold the **MODE** key until **RESPONSE** is displayed. And then, release the key.
- 2 Press the **MODE** key to select a rate of the response adjustment. Either **FAST**, **MID.** or **SLOW** can be selected.
- 3 After a few seconds of inactivity, or when the **PRINT** key is pressed, the balance displays **End**. Then, it returns to the weighing mode and displays the updated response indicator. The response indicator remains displayed for a while.

### Note

Setting the response rate automatically changes the “Condition (*Cond*)” and “Display refresh rate (*SPd*)” parameters of “Environment, Display (*bASFnC*)” in the function table, as shown below:

Indicator	<i>Cond</i> (Condition)	<i>SPd</i> (Display refresh rate)
FAST	0	2
MID.	1	0
SLOW	2	0

When the balance is to be used with other setting combinations, set each parameter in the function table.

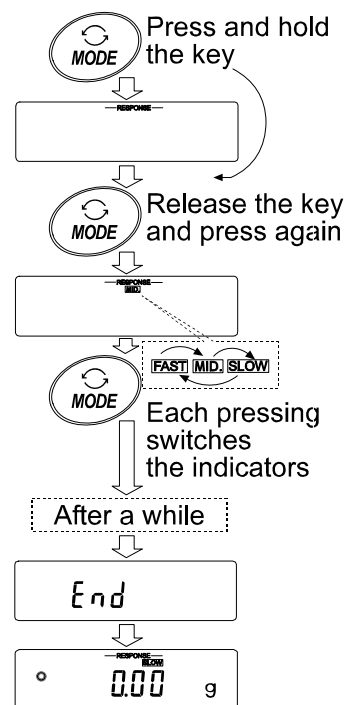



# 7. CALIBRATION

## 7-1 Calibration Mode

The FX-*i* series balance has the following two modes.

- Calibration using an external weight
- Calibration test using an external weight (Calibration test does not perform calibration.)

### Terms

The following terms are defined as follows:

- External weight = A weight that you have. Referred to as a calibration weight when used for calibration.
- Calibration weight = A weight used for calibration
- Target weight = An external weight used for calibration test

### Caution

- Calibration adjusts the balance for accurate weighing.  
Besides periodic calibration and before each use, perform calibration when:
  - The balance is installed for the first time.
  - The balance has been moved.
  - The ambient environment has changed.
- Do not allow vibration or drafts to affect the balance during calibration.
- To output the data for GLP using the RS-232C serial interface, set “GLP output ( *inF0* )” of “Data output ( *dout* )”. For details, refer to “9. FUNCTION TABLE”.
- Calibration test is available only when “GLP output ( *inF0* )” of “Data output ( *dout* )” is set to “1” or “2”.

### Caution on using an external weight

- The accuracy of an external weight will influence the accuracy of weighing. Select an appropriate weight as listed below:

Model	Usable calibration weight	Adjustable range
FX-120 <i>i</i>	<b>100 g</b> , 50 g	-0.050 g to +0.050 g
FX-200 <i>i</i>	<b>200 g</b> , 100 g	
FX-300 <i>i</i>	300 g, <b>200 g</b> , 100 g	
FX-1200 <i>i</i>	<b>1000 g</b> , 500 g,	-0.50 g to +0.50 g
FX-2000 <i>i</i>	<b>2000 g</b> , 1000 g	
FX-3000 <i>i</i>	3000 g, <b>2000 g</b> , 1000 g	

The calibration weight in bold type: factory setting

The calibration weight value can be adjusted within the range above.

### Display

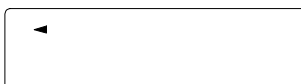

- This indicator means “the balance is measuring calibration data”. Do not allow vibration or drafts to affect the balance while this indicator is displayed.

## 7-2 Calibration Using an External Weight

This function calibrates the balance using an external weight.

### Operation

- 1 Connect the AC adapter and warm up the balance for at least 30 minutes with nothing on the pan.
- 2 Press and hold the **CAL** key until **[CAL out]** is displayed, and then release the key.
- 3 The balance displays **[CAL 0]**.
  - If you want to change the calibration weight (a list of usable weights is shown on page 23), press the **SAMPLE** key and proceed to step 4.
  - If you use the calibration weight value stored in the balance, proceed to step 5.
- 4 Specify the calibration weight value as follows:

**[SAMPLE]** key To switch the display condition to: "All of the segments blinking" (calibration weight selection mode) or "The last two digits blinking" (value adjustment mode).

**[RE-ZERO]** key (To increase the value)

**[MODE]** key (To decrease the value)

To select the calibration weight or adjust the value.

**[PRINT]** key To store the new weight value. Even if the AC adapter is removed, the data is maintained in non-volatile memory.

**[CAL]** key To cancel the operation and return to **[CAL 0]**.

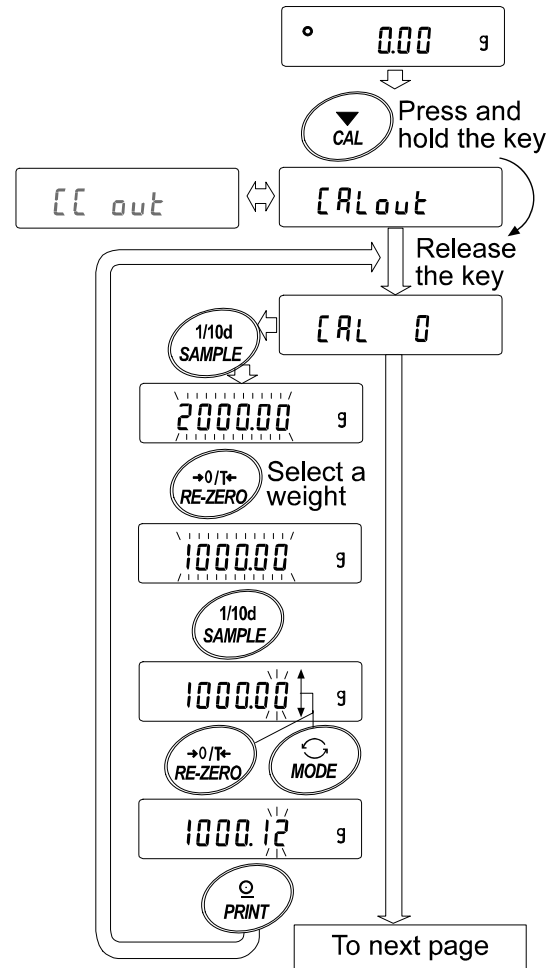

e.g. Calibration weight value  
1000.12 g

5 Confirm that there is nothing on the pan and press the **PRINT** key. The balance measures the zero point. Do not allow vibration or drafts to affect the balance.

The balance displays the calibration weight value.

6 Place the displayed calibration weight on the pan and press the **PRINT** key. The balance measures the calibration weight. Do not allow vibration or drafts to affect the balance.

7 The balance displays **End**. Remove the weight from the pan.

8 When the GLP output is set, the balance displays **GLP** and outputs "Calibration Report".

9 The balance will automatically return to the weighing mode.

10 Place the calibration weight on the pan and confirm that the value displayed is within  $\pm 2$  digits of the specified value. If it is not within the range, check the ambient conditions such as breeze and vibration, also check the weighing pan. Then, repeat steps 1 to 9.

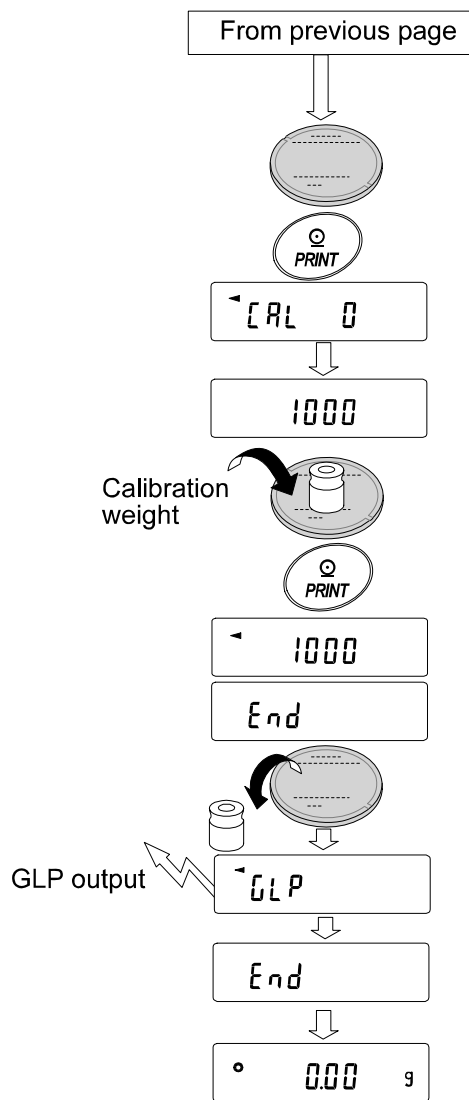

## 7-3 Calibration Test Using an External Weight

This function tests the balance weighing accuracy using an external weight and outputs the result. This is available only when the “GLP output (INF0)” parameter is set to “1” or “2”. (Calibration test does not perform calibration.)

### Operation

- 1 Connect the AC adapter and warm up the balance for at least 30 minutes with nothing on the pan.
- 2 Press and hold the **CAL** key until **[[out** is displayed, and then release the key.
- 3 The balance displays **[[ 0**.
  - If you want to change the target weight (a list of usable weights is shown on page 23), press the **SAMPLE** key and proceed to step 4.
  - If you use the target weight value stored in the balance, proceed to step 5.
- 4 Specify the target weight value as follows:

**SAMPLE** key To switch the display condition to: “All of the segments blinking” (target weight selection mode) or “The last two digits blinking” (value adjustment mode).

**RE-ZERO** key (To increase the value)

**MODE** key (To decrease the value)

To select the target weight or adjust the value.

**PRINT** key

To store the new weight value. Even if the AC adapter is removed, the data is maintained in non-volatile memory.

**CAL** key

To cancel the operation and return to **[[ 0**.

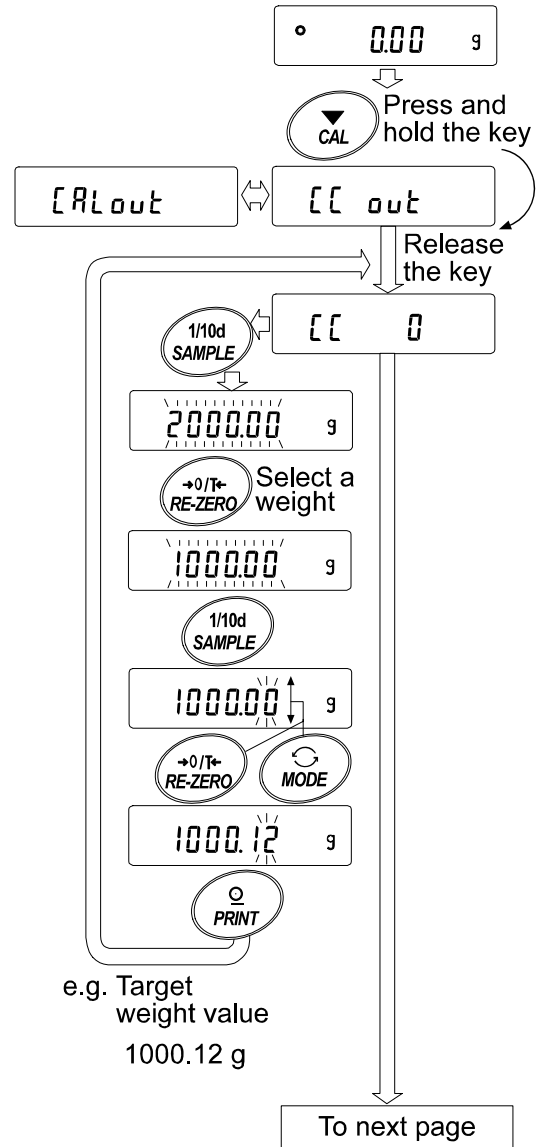

- 5 Confirm that there is nothing on the pan and press the **PRINT** key. The balance measures the zero point and displays the measured value. Do not allow vibration or drafts to affect the balance.  
The balance displays the target weight value.

- 6 Place the displayed target weight on the pan and press the **PRINT** key. The balance measures the target weight and displays the measured value. Do not allow vibration or drafts to affect the balance.

- 7 The balance displays **End**. Remove the weight from the pan.

- 8 When the GLP output is set, the balance displays **GLP** and outputs "Calibration Test Report".

- 9 The balance will automatically return to the weighing mode.

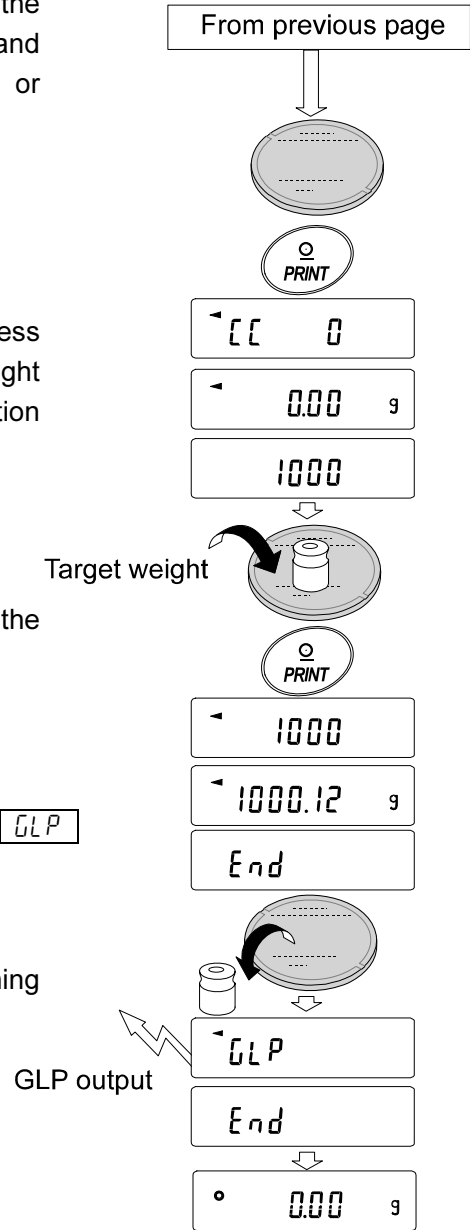

# 8. FUNCTION SWITCH AND INITIALIZATION

## 8-1 Permit or Inhibit

The balance stores parameters that must not be changed unintentionally. There are two switches for the purpose of protecting these parameters. Each switch can select either “permit” or “inhibit”. The “inhibit” protects parameters against unintentional operations.

### Switches

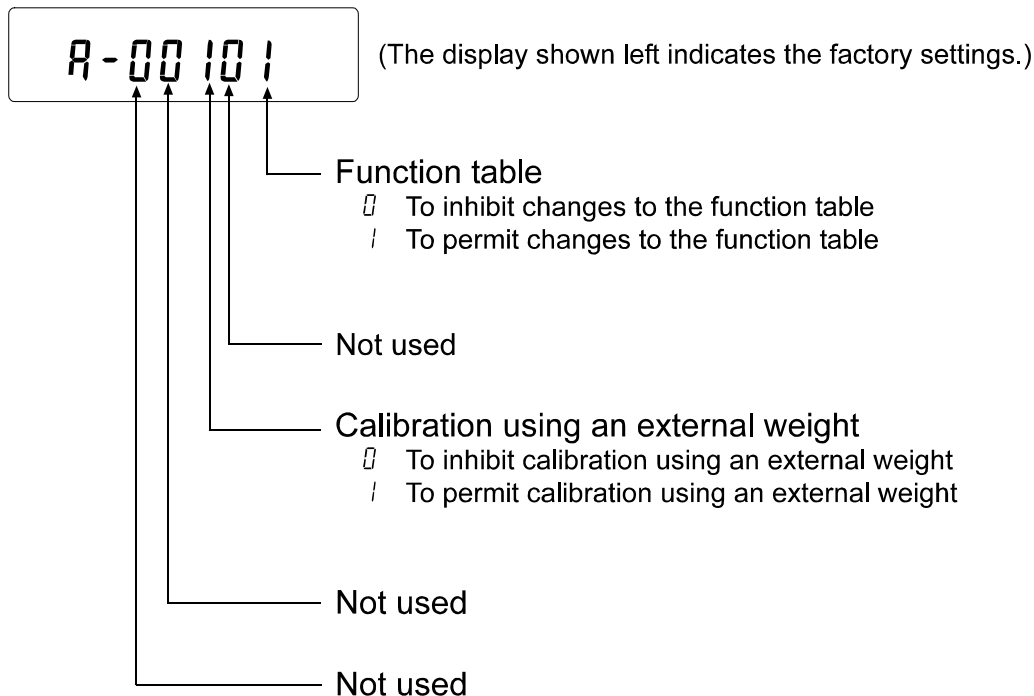

### Operation

- 1 Press the **ON:OFF** key to turn off the display.
- 2 While pressing and holding the **PRINT** key and the **SAMPLE** key, press the **ON:OFF** key. The balance displays **P5**.
- 3 Press the **PRINT** key. Then the balance displays the function switches.
- 4 Set the switches using the following keys.
  - SAMPLE** key To select the switch to change the parameter.
  - RE-ZERO** key To change the parameter of the switch selected.
    - 0: To inhibit changes. 1: To permit changes
  - PRINT** key To store the new parameter and return to the weighing mode.
  - CAL** key To cancel the operation ( **Err** is displayed.) To return to the weighing mode, press the **CAL** key once again.

## 8-2 Initializing the Balance

This function returns the following parameters to factory settings.

- Calibration data
- Function table
- The sample unit mass value (counting mode), 100% reference mass value (percent mode)
- External calibration weight
- Function switch settings
- Statistical data

### Note

Be sure to calibrate the balance after initialization.

### Operation

- 1 Press the **ON:OFF** key to turn off the display.
- 2 While pressing and holding the **PRINT** key and the **SAMPLE** key, press the **ON:OFF** key. The balance displays **PS**.
- 3 Press the **SAMPLE** key to display **[Lr**.
- 4 Press the **PRINT** key.  
To cancel this operation, press the **CAL** key.
- 5 Press the **RE-ZERO** key.
- 6 Press the **PRINT** key to initialize the balance.

The balance will automatically return to the weighing mode.

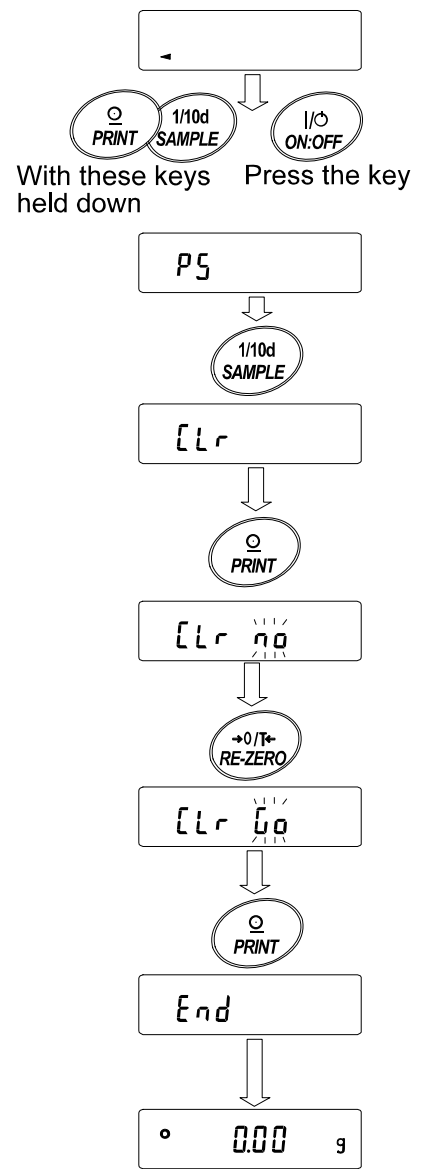

# 9. FUNCTION TABLE

The function table reads or rewrites the parameters that are stored in the balance. These parameters stored, even if the AC adapter is removed, are maintained in non-volatile memory.

## 9-1 Structure and Sequence of the Function Table

The function table menu consists of two layers. The first layer is the “Class” and the second layer is the “Item”. Each item stores a parameter.

### Example

This example sets “Auto print mode A” for “Data output mode” and “100 digits” for “Auto print difference”.

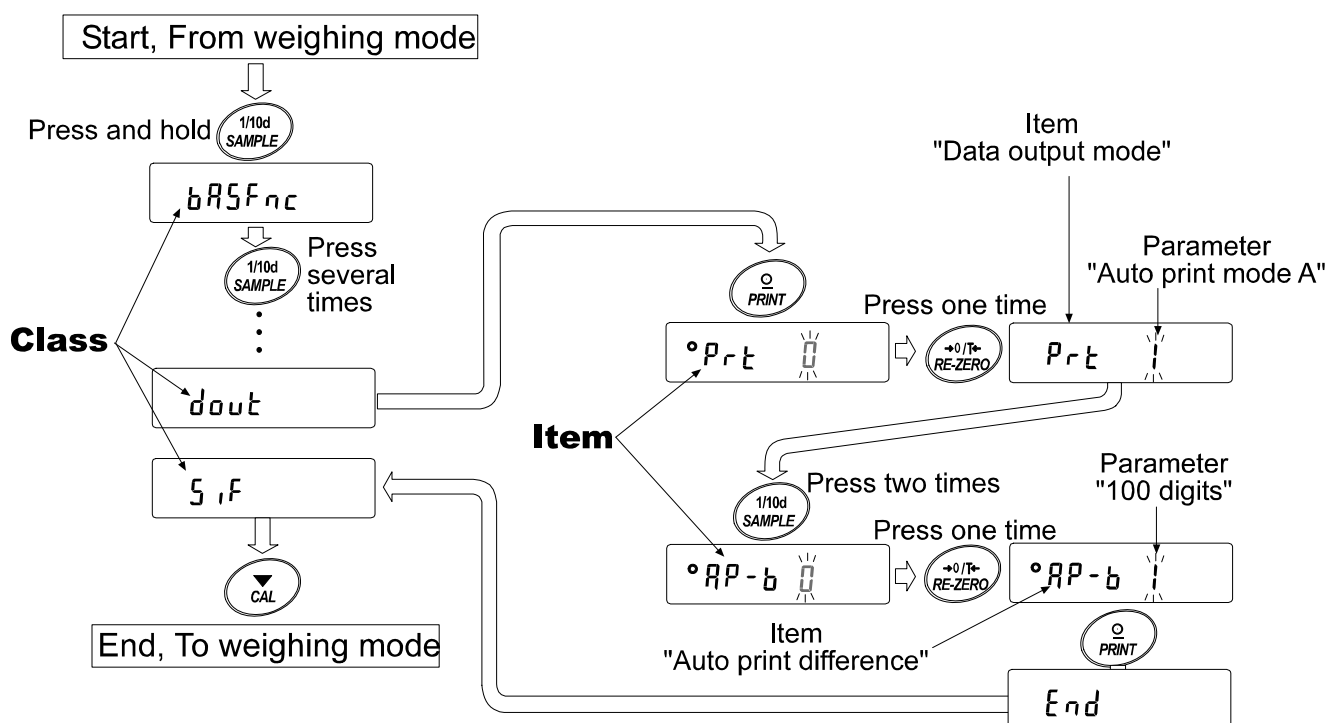





## 9-2 Display and Keys

Display/Key	Description
	The symbol “○” indicates that the parameter displayed is in effect.
	When pressed and held in the weighing mode, enters the function table mode. Selects the class or item in the function table mode.
	Changes the parameter.
	When a class is displayed, moves to an item in the class. When an item is displayed, stores the new parameter and displays the next class.
	When an item is displayed, cancels the new parameter and displays the next class. When a class is displayed, exits the function table mode and returns to the weighing mode.



## 9-3 Details of the Function Table

Class	Item and Parameter	Description
<i>bRSFnc</i> Environment Display	<i>Cond</i> Condition	0 Fast response, sensitive value 
		1 
		2 Slow response, stable value 
	<i>St-b</i> Stability band width	0 Stable range is $\pm 1$ digit 
		1 
		2 Stable range is $\pm 3$ digits
	<i>Hold</i> Hold function	0 OFF
		1 ON
	<i>trc</i> Zero tracking	0 OFF
		1 Normal
2 Strong		
3 Very strong		
<i>SPd</i> Display refresh rate	0 5 times/second	
	1 10 times/second	
	2 20 times/second	
<i>Pnt</i> Decimal point	0 Point (.)	
	1 Comma (,)	
<i>P-on</i> Auto display-ON	0 OFF	
	1 ON	
<i>P-off</i> Auto display-OFF	0 OFF	
	1 ON (10 minutes)	
<i>rn0</i> Display at start	0 Displays	
	1 Does not display	
<i>bEEP</i> Beep	0 Does not sound	
	1 Sounds	
<i>CP Fnc</i> Comparator	<i>CP</i> Comparator mode	0 No comparison
		1 Comparison, excluding "near zero" when stable value or overloaded
		2 Comparison, including "near zero" when stable value or overloaded
		3 Continuous comparison, excluding "near zero"
		4 Continuous comparison, including "near zero"
	<i>bEP-</i> LO buzzer	0 ON
		1 OFF
	<i>bEP-</i> OK buzzer	0 ON
1 OFF		
<i>bEP-</i> HI buzzer	0 ON	
	1 OFF	
<i>CP Hi</i> Upper limit	Refer to "9-9 Comparator Function".	
<i>CP Lo</i> Lower limit		

▪: Factory settings. Digit is a unit of minimum weighing value

Class	Item and Parameter	Description
<i>dout</i> Data output	<i>Prt</i> Data output mode	▪ 0 Key mode Accepts the <b>PRINT</b> key only when the display is stable.
		1 Auto print mode A (Reference = zero) Outputs data when the display is stable and conditions of <i>AP-P</i> , <i>AP-b</i> and the reference value are met.
		2 Auto print mode B (Reference = last stable value)
		3 Stream mode Outputs data continuously.
		4 Key mode B (Immediately) Accepts the <b>PRINT</b> key regardless of the display condition.
		5 Key mode C (When stable) Accepts the <b>PRINT</b> key immediately when the display is stable, or waits for the display to be stable when not.
		6 Interval output mode Uses interval output mode.
	<i>AP-P</i> Auto print polarity	▪ 0 Plus only Displayed value > Reference
		1 Minus only Displayed value < Reference
		2 Both Regardless of displayed value
	<i>AP-b</i> Auto print difference	0 10 digits
		▪ 1 100 digits
		2 1000 digits
	<i>int</i> Interval time	0 Every measurement
		▪ 1 2 seconds
		2 5 seconds
		3 10 seconds
		4 30 seconds
		5 1 minute
		6 2 minute
		7 5 minute
	8 10 minute	
	<i>PUSE</i> Data output pause	▪ 0 No pause Selects the data output interval.
		1 Pause (1.6 seconds)
	<i>AL-F</i> Auto feed	▪ 0 Not used Selects whether or not automatic feed is performed.
		1 Used
	<i>inf0</i> GLP output	▪ 0 No output
		1 AD-8121 format
		2 General data format
	<i>Ar-d</i> Zero after output	▪ 0 Not used Adjusts zero automatically after data is output
		1 Used

▪ Factory settings. Digit is a unit of minimum weighing value

Class	Item and Parameter	Description		
SIF Serial interface	bPS Baud rate	0	600 bps	
		1	1200 bps	
		▪ 2	2400 bps	
		3	4800 bps	
		4	9600 bps	
		5	19200 bps	
	btPr Data bit, parity bit	▪ 0	7 bits, even	
		1	7 bits, odd	
		2	8 bits, none	
	CrLF Terminator	▪ 0	CR LF	CR: ASCII code 0Dh LF: ASCII code 0Ah
		1	CR	
	tYPE Data format	▪ 0	A&D standard format	Refer to "9-6 Description of the Item "Data Format".
		1	DP format	
		2	KF format	
3		MT format		
4		NU format		
5		CSV format		
t-UP Timeout	0	No limit	Selects the wait time to receive a command.	
	▪ 1	1 second		
ErCd AK, Error code	▪ 0	No output	AK:ASCII code 06h	
	1	Output		
nLt Programmable-unit (Multi-unit)	Sets an arbitrary coefficient.		Available only when programmable-unit mode is selected.	
Unit	Refer to "4. WEIGHING UNITS".			
id ID number	Refer to "10. ID NUMBER AND GLP REPORT"			
AP Fnc Application	APF Application function	▪ 0	Normal weighing mode	
		1	Capacity indicator	
		2	Statistical calculation mode	
	StatRAF Statistical function mode output items	▪ 0	Number of data, sum	
		1	Number of data, sum, maximum, minimum, average, range (maximum-minimum)	
2	Number of data, sum, maximum, minimum, average, range (maximum-minimum), standard deviation, coefficient of variation			

▪ : Factory settings.

### Caution

The balance may not transmit the data completely at the specified refresh rate, depending on the baud rate.

When a refresh rate of 20 times/second is used, set the baud rate to 4800 bps or higher.

## 9-4 Description of the Class “Environment, Display”

### Condition ( *Cond* )

*Cond 0*



*Cond 2*

This parameter is for sensitive response to the fluctuation of a weight value. Used for powder target weighing, weighing a very light sample or when quick response weighing is required.

After setting, the balance displays **FAST**.

This parameter is for stable weighing with slow response. Used to prevent a weight value from drifting due to vibration or drafts.

After setting, the balance displays **SLOW**.

#### Note

With “Hold function (*Hold*)” set to “ON ( *!* )”, this item is used to set the averaging time.

### Stability band width ( *St-b* )

This item controls the width to regard a weight value as a stable value. When the fluctuation per second is less than the parameter, the balance displays the stabilization indicator and outputs the data. The parameter influences the “Auto print mode”

*St-b 0*



*St-b 2*

This parameter is for sensitive response of the stabilization indicator. Used for exact weighing.

This parameter ignores slight fluctuation of a weight value. Used to prevent a weight value from drifting due to vibration or drafts.

#### Note

With “Hold function (*Hold*)” set to “ON ( *!* )”, this item is used to set the stabilization range.

### Hold function ( *Hold* ) (Animal weighing mode)

This function is used to weigh a moving object such as an animal.

When the weight data is over the weighing range from zero and the display fluctuation is within the stabilization range for a fixed period of averaging time, the processing indicator illuminates and the balance displays the average weight of the animal. When the animal is removed from the weighing pan, the display returns to zero automatically.

This function is available only when the hold function parameter is set to “*!*” (the animal mode indicator **ANIMAL** illuminates) and any weighing unit other than the counting mode is selected.

The stabilization range and averaging time are set in “Condition (*Cond*)” and “Stability band width (*St-b*)”.

Weighing range		Averaging time		Stabilization range	
FX-120 <i>i</i> / 200 <i>i</i> / 300 <i>i</i>	0.200 g or over	<i>Cond 0</i>	2 seconds Faster	<i>St-b 0</i>	Lesser
FX-1200 <i>i</i> / 2000 <i>i</i> / 3000 <i>i</i>	2.00 g or over	<i>Cond 1</i>	4 seconds	<i>St-b 1</i>	
		<i>Cond 2</i>	8 seconds More accurate	<i>St-b 2</i>	Greater

### **Zero tracking ( $t_{rc}$ )**

This function tracks zero point drift caused by changes in the environment and stabilizes the zero point. When the weight data is only a few digits, turn the function off for accurate weighing.

#### **Note**

**Digit, when used for the FX-i series balance, indicates a unit of minimum weighing value.**

$t_{rc} 0$	The tracking function is not used. Used for weighing a very light sample.
$t_{rc} 1$	The tracking function is used. Normal zero tracking.
$t_{rc} 2$	The tracking function is used. Strong zero tracking.
$t_{rc} 3$	The tracking function is used. Very strong zero tracking.

### **Display refresh rate ( $SPd$ )**

Period to refresh the display. This parameter influences “Stream mode” along with “Baud rate” and “Data output pause”

#### **Note**

**This item is selected automatically when the response rate is changed.**

### **Decimal point ( $P_{nt}$ )**

The decimal point format can be selected.

### **Auto display-ON ( $P_{on}$ )**

When the AC adapter is connected, the display is automatically turned on in the weighing mode, without the ON:OFF key operation. Used when the balance is built into an automated system. 30-minute warm up is necessary for accurate weighing.

### **Auto display-OFF ( $P_{off}$ )**

When the AC adapter is connected and no operation is performed (inactivity state) for 10 minutes, the display is automatically turned off and the standby indicator is illuminated.

## 9-5 Description of the Item “Data Output Mode”

---

The parameter setting of the “Data output mode ( *Prt* )” applies to the performance when the data is transmitted using the RS-232C serial interface.

### Key mode

When the **PRINT** key is pressed with the stabilization indicator turned on, the balance outputs the weight data and the display blinks one time.

Required setting	<i>dout</i>	<i>Prt 0</i>	Key mode
------------------	-------------	--------------	----------

### Auto print modes A and B

When the displayed value is stable and the conditions of “Auto print polarity”, “Auto print difference” and reference value are met, the balance outputs the weight data.

When the **PRINT** key is pressed with the stabilization indicator turned on, the balance outputs the data and the display blinks one time.

Mode A: Required setting	<i>dout</i>	<i>Prt 1</i>	Auto print mode A (reference = zero)
	<i>dout</i>	<i>RP-P</i>	Auto print polarity
	<i>dout</i>	<i>RP-b</i>	Auto print difference

Example	“For outputting the weight value each time a sample is added, with “ <i>Rr-d</i> ” set to “1” (to adjust zero after the data is output).”
---------	---

Mode B: Required setting	<i>dout</i>	<i>Prt 2</i>	Auto print mode B (reference = last stable value)
	<i>dout</i>	<i>RP-P</i>	Auto print polarity
	<i>dout</i>	<i>RP-b</i>	Auto print difference

Example	“For outputting the weight value while a sample is added.”
---------	--

### Stream mode

The balance outputs the weight data continuously regardless of the display condition. The display does not blink in this mode.

Required setting	<i>dout</i>	<i>Prt 3</i>	Stream mode
	<i>bRSFnC</i>	<i>SPd</i>	Display refresh rate
	<i>SIF</i>	<i>bPS</i>	Baud rate

Example	“For monitoring data on a computer”
---------	-------------------------------------

### Caution

**The balance may not transmit the data completely at the specified refresh rate and baud rate. Set the baud rate higher.**

### Key mode B

When the **PRINT** key is pressed, the balance outputs the weight data, regardless of the display condition. The display does not blink in this mode.

### Key mode C

When the **PRINT** key is pressed with the stabilization indicator turned on, the balance outputs the weight data. When the stabilization indicator is not on, the balance waits for the indicator to turn on and outputs the data. The balance blinks one time in this mode.

## Interval output mode

The weight data is periodically output.

When the **PRINT** key is pressed, the balance starts to output the weight data at a preset interval time. When the **PRINT** key is pressed again, the balance stops outputting the weight data.

Required setting      *dout*      *Pr t 6*      Interval output mode

*dout*      *int*      Interval time

Example      "For outputting the weight data periodically."

### Caution

**The balance may not transmit the data completely at the specified interval times and baud rate. Set the baud rate higher.**

## 9-6 Description of the Item "Data Format"

### A&D standard format      *S IF TYPE 0*

This format is used when the peripheral equipment can receive the A&D format. If an AD-8121B is used, set the printer to MODE 1 or 2.

- This format consists of fifteen characters excluding the terminator.
- A header of two characters indicates the balance condition.
- The polarity sign is placed before the data with the leading zeros. If the data is zero, the plus sign is used.
- The unit, consisting of three characters, follows the data.

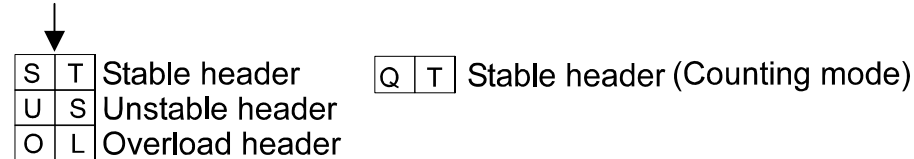
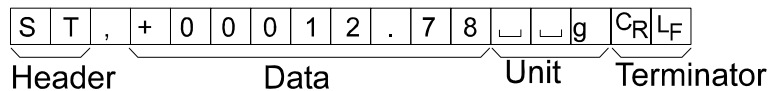

### DP (Dump print) format      *S IF TYPE 1*

This format is used when the peripheral equipment can not receive the A&D format. If an AD-8121B is used, set the printer to MODE 3.

- This format consists of sixteen characters excluding the terminator.
- A header of two characters indicates the balance condition. No overload header is used.
- The polarity sign is placed before the data, with spaces in place of leading zeros, if the data is not zero or overloaded.
- The unit, consisting of three characters, follows the data.

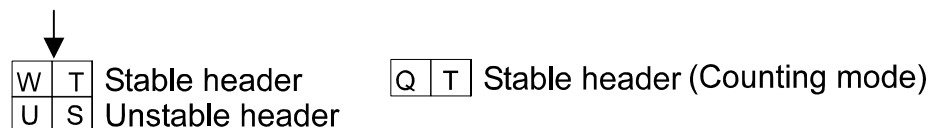
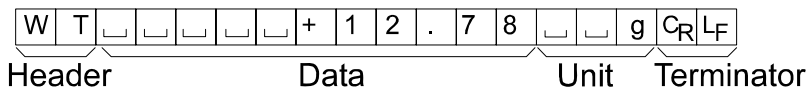

### KF format *S, F TYPE 2*

This is the Karl-Fischer moisture meter format and is used when the peripheral equipment can only communicate using this format.

- This format consists of fourteen characters excluding the terminator.
- This format has no header characters.
- The polarity sign is placed before the data, with spaces in place of leading zeros, if the data is not zero or overloaded.
- This format outputs the unit only for a stable value.

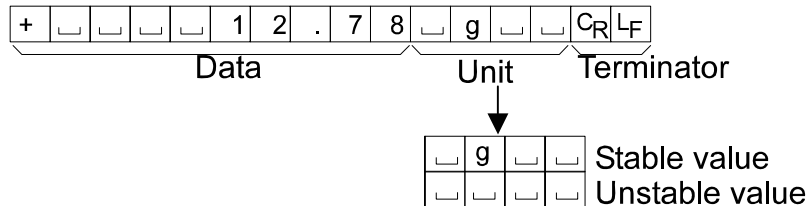

### MT format *S, F TYPE 3*

- A header of two characters indicates the balance condition.
- The polarity sign is used only for negative data.
- The weight data uses spaces in place of the leading zeros.
- The character length of this format changes dependent upon the unit

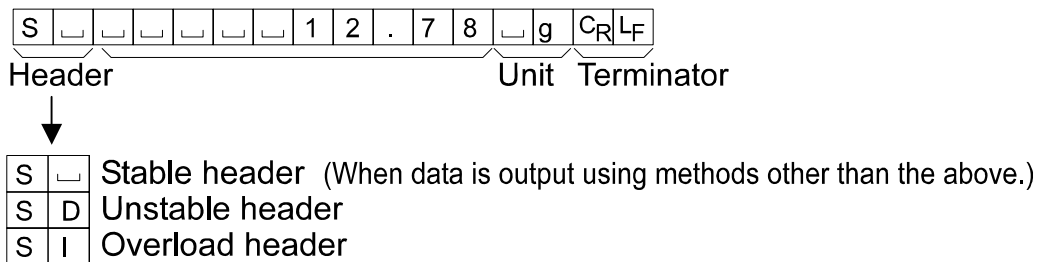

### NU (numerical) format *S, F TYPE 4*

This format outputs only numerical data.

- This format consists of nine characters excluding the terminator.
- The polarity sign is placed before the data with the leading zeros. If the data is zero, the plus sign is used.

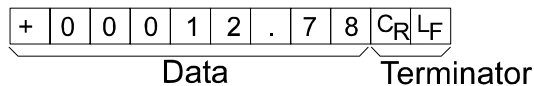

### CSV format *S, F TYPE 5*

- Separates the data of A&D standard format and the unit by a comma (,).
- Outputs the unit even when the data is overloaded.

ST,+00012.78, □ □ g<CR><LF>  
 Weight data

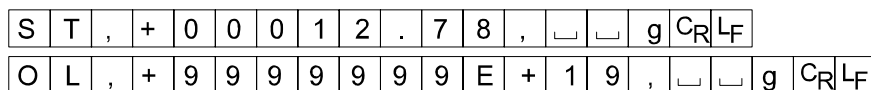



## 9-7 Data Format Examples

### Stable

°	127	g
---	-----	---

A&D	S	T	,	+	0	0	0	0	1	.	2	7	␣	␣	g	C <sub>R</sub>	L <sub>F</sub>	
DP	W	T	␣	␣	␣	␣	␣	␣	+	1	.	2	7	␣	␣	g	C <sub>R</sub>	L <sub>F</sub>
KF	+	␣	␣	␣	␣	␣	␣	1	.	2	7	␣	g	␣	␣	C <sub>R</sub>	L <sub>F</sub>	
MT	␣	␣	␣	␣	␣	␣	␣	1	.	2	7	␣	g	␣	␣	C <sub>R</sub>	L <sub>F</sub>	
NU	+	0	0	0	0	1	.	2	7	C <sub>R</sub>	L <sub>F</sub>							

### Unstable

-18369	g
--------	---

A&D	U	S	,	-	0	0	1	8	3	.	6	9	␣	␣	g	C <sub>R</sub>	L <sub>F</sub>	
DP	U	S	␣	␣	␣	␣	-	1	8	3	.	6	9	␣	␣	g	C <sub>R</sub>	L <sub>F</sub>
KF	-	␣	␣	␣	1	8	3	.	6	9	␣	␣	␣	␣	␣	C <sub>R</sub>	L <sub>F</sub>	
MT	S	D	␣	␣	␣	-	1	8	3	.	6	9	␣	␣	g	C <sub>R</sub>	L <sub>F</sub>	
NU	-	0	0	1	8	3	.	6	9	C <sub>R</sub>	L <sub>F</sub>							

### Overload Positive error

E	g
---	---

A&D	O	L	,	+	9	9	9	9	9	9	9	E	+	1	9	C <sub>R</sub>	L <sub>F</sub>	
DP	␣	␣	␣	␣	␣	␣	␣	␣	␣	␣	␣	␣	␣	␣	␣	␣	C <sub>R</sub>	L <sub>F</sub>
KF	␣	␣	␣	␣	␣	␣	H	␣	␣	␣	␣	␣	␣	␣	␣	␣	C <sub>R</sub>	L <sub>F</sub>
MT	S	I	+	C <sub>R</sub>	L <sub>F</sub>													
NU	+	9	9	9	9	9	9	9	9	C <sub>R</sub>	L <sub>F</sub>							

### Overload Negative error

-E	g
----	---

A&D	O	L	,	-	9	9	9	9	9	9	9	E	+	1	9	C <sub>R</sub>	L <sub>F</sub>	
DP	␣	␣	␣	␣	␣	␣	␣	-	E	␣	␣	␣	␣	␣	␣	␣	C <sub>R</sub>	L <sub>F</sub>
KF	␣	␣	␣	␣	␣	␣	L	␣	␣	␣	␣	␣	␣	␣	␣	␣	C <sub>R</sub>	L <sub>F</sub>
MT	S	I	-	C <sub>R</sub>	L <sub>F</sub>													
NU	-	9	9	9	9	9	9	9	9	C <sub>R</sub>	L <sub>F</sub>							

- ␣ Space, ASCII 20h
- C<sub>R</sub> Carriage Return, ASCII 0Dh
- L<sub>F</sub> Line Feed, ASCII 0Ah

Units		A&D	D.P.	KF	MT
g	g	□□g	□□g	□g□□	□g
Counting mode	PCS	□PC	□PC	□p c s	□P C S
Precent mode	%	□□%	□□%	□%□□	□%
Ounce (Avoir)	oz	□o z	□o z	□o z□	□o z
Pound	lb	□l b	□l b	□l b□	□l b
Pound Ounce	LOZ	□o z	□o z	□o z□	□o z
Troy Ounce	ozt	o z t	o z t	□o z t	□o z t
Metric Carat	ct	□c t	□c t	□c t□	□c t
Momme	mom	m o m	m o m	□m o m	□m o
Pennyweight	dwt	d w t	d w t	□d w t	□d w t
Grain	GN	□G N	□G N	□g r□	□G N
Tael (HK general, Singapore)	tl	□t l	□t l	□t l s	□t l
Tael (HK, jewelry)	tl	□t l	□t l	□t l h	□t l
Tael (Taiwan)	tl	□t l	□t l	□t l t	□t l
Tael (China)	tl	□t l	□t l	□t l c	□t l
Tola (India)	tol	□□t	□□t	□t o l	□t
Messghal	mes	m e s	m e s	□M S□	□m
Multi	MLT	M L T	M L T	□M L T	□M L T

□ Space, ASCII 20h

#### Note

When “Pound Ounce” is selected, the data is output with the unit of ounce (oz).

## 9-8 Description of the Item “Application Function”

### Capacity indicator (APF 1)

In the weighing mode, the indicator displays the weight data relative to the weighing capacity in percentage. (Zero = 0%, maximum capacity = 100%)

### Statistical calculation mode (APF 2)

The mode statistically calculates the weight data, and displays or outputs the results. For details, refer to “5-4 Statistical Calculation Mode”.

## 9-9 Comparator Function

The results of the comparison are indicated by **HI** **OK** **LO** on the display.

Operating conditions:

- No comparison

- Comparison when the weight data is stable or overloaded, excluding “near zero”
- Comparison when the weight data is stable or overloaded, including “near zero”
- Continuous comparison, excluding “near zero”
- Continuous comparison, including “near zero”

To compare, use:

- Upper limit value and lower limit value

Input method:

- Digital input

### Note

**“Near zero” means that the weight value is within  $\pm 10$  digits of the minimum weighing value. For example, using a FX-3000i in gram mode, the range of  $\pm 0.10$  g is “near zero”.**

For the description of “Comparator (CP Fnc)”, refer to “9-3 Details of the Function Table”.

### Setting example

(Continuous comparison, excluding “near zero”, upper limit and lower limit values, digital input)

#### Selecting a comparator mode

- 1 Press and hold the **SAMPLE** key until **bRSFnc** of the function table is displayed.
- 2 Press the **SAMPLE** key several times to display **CP Fnc**.
- 3 Press the **PRINT** key.
- 4 Press the **RE-ZERO** key several times to display **CP 3**.
- 5 Press the **PRINT** key to store the selected mode.

#### Entering the upper limit value

- 6 With **CP Hi** displayed, press the **PRINT** key. The current setting of the upper limit value is displayed with all the digits blinking.
  - When the current setting is not to be changed, press the **PRINT** or **CAL** key to proceed to step 7.
  - When the current setting is to be changed, press the **RE-ZERO** key. Change the setting using the following keys.

<b>SAMPLE</b> key	To select the digit to change the value.
<b>RE-ZERO</b> key	To change the value of the digit selected.
<b>MODE</b> key	To switch the polarity.
<b>PRINT</b> key	To store the new setting and go to step 7.
<b>CAL</b> key	To cancel the new setting and go to step 7.

#### Entering the lower limit value

- 7 With **CP Lo** displayed, press the **PRINT** key. The current setting of the lower limit value is displayed with all the digits blinking.
  - When the current setting is not to be changed, press the **PRINT** or **CAL** key to proceed to step 8.
  - When the current setting is to be changed, press the **RE-ZERO** key. Change the setting using the following keys.

<b>SAMPLE</b> key	To select the digit to change the value.
<b>RE-ZERO</b> key	To change the value of the digit selected.
<b>MODE</b> key	To switch the polarity.
<b>PRINT</b> key	To store the new setting and go to step 8.
<b>CAL</b> key	To cancel the new setting and go to step 8.

- 8 Press the **CAL** key to exit the comparator function and return to the weighing mode.

# 10. ID NUMBER AND GLP REPORT

- The ID number is used to identify the balance when Good Laboratory Practice (GLP) is used.
- The ID number is maintained in non-volatile memory even if the AC adapter is removed.
- The GLP output format is selected at “GLP output ( *inF0* )” of the function table and can be output to a personal computer or printer using the RS-232C serial interface.
- The GLP output format includes the balance manufacturer, model, serial number, ID number and space for signature for weight data, and the weight used and results for calibration or calibration test data.

When the AD-8121B is used, the date and time can be printed using the AD-8121B clock and calendar function. In this case, set the “GLP output ( *inF0* )” parameter to “1”.

- The balance can output the following reports for GLP.
  - “Calibration report” of the calibration, using an external weight.
  - “Calibration test report” of the calibration test, using an external weight.
  - “Title block” and “End block” for the weight data.

## 10-1 Setting the ID Number

- 1 Press and hold the **SAMPLE** key until **bRSFnC** of the function table is displayed.
- 2 Press the **SAMPLE** key several times to display **id**.
- 3 Press the **PRINT** key. Set the ID number using the following keys.

- |                    |   |
|--------------------|---|
| <b>SAMPLE</b> key  | To select the digit to change the value.  |
| <b>RE-ZERO</b> key | To set the character of the digit selected. Refer to the display character set shown below. |
| <b>PRINT</b> key   | To store the new ID number and display <b>RP FnC</b>  |
| <b>CAL</b> key     | To cancel the new ID number and display <b>RP FnC</b>                                       |

- 4 Press the **CAL** key to return to the weighing mode.

### Display character set

0	1	2	3	4	5	6	7	8	9	-	_	A	B	C	D	E	F	G	H	I	J	K	L	M	N	O	P	Q	R	S	T	U	V	W	X	Y	Z
0	1	2	3	4	5	6	7	8	9	-	_	R	b	L	d	E	F	G	H	i	J	L	n	n	o	P	q	r	S	t	U	v	w	x	y	z	

\_ Space

## 10-2 GLP Report

Set the following parameters to output the report.

- To print the report, set the “GLP output ( *inF0* )” parameter to “1” and use MODE 3 of the AD-8121B. For details on using the printer, refer to “14-1 Connection to the AD-8121B Printer”. If the time and date are not correct, adjust the AD-8121B clock and calendar.
- To output the report to a personal computer using the RS-232C serial interface, set the “GLP output ( *inF0* )” parameter to “2”.

### Note

For operational details about calibration and calibration test, refer to “7. CALIBRATION”.

## Calibration report using an external weight

When the setting is “*inf0 1*”:

When the setting is “*inf0 2*”:

### AD-8121 format

```

      A & D
MODEL   FX-3000i
S/N     01234567
ID      ABCDEFG
DATE    2006/02/06
TIME    12:23:34
CALIBRATED(EXT.)
CAL.WEIGHT
      +20000.00 g
SIGNATURE
-----
    
```

← Manufacturer →  
 ← Model →  
 ← Serial number →  
 ← ID number →  
 ← Date →  
 ← Time →  
 ← Calibration type →  
 ← Calibration weight →  
 ← Signature →

### General data format

```

_____A_&_D<TERM>
MODEL___FX-3000i<TERM>
S/N_____01234567<TERM>
ID_____ABCDEFG<TERM>
DATE<TERM>
<TERM>
TIME<TERM>
<TERM>
CALIBRATED(EXT.)<TERM>
CAL.WEIGHT<TERM>
_____+2000.00__g<TERM>
SIGNATURE<TERM>
<TERM>
<TERM>
-----<TERM>
<TERM>
<TERM>
    
```

␣ Space, ASCII 20h  
 <TERM> Terminator, C<sub>R</sub>, L<sub>F</sub> or C<sub>R</sub>  
 C<sub>R</sub> Carriage return, ASCII 0Dh  
 L<sub>F</sub> Line feed, ASCII 0Ah

## Calibration test report using an external weight

(Calibration test does not perform calibration.)

When the setting is “*inf0 1*”:

When the setting is “*inf0 2*”:

### AD-8121 format

```

      A & D
MODEL   FX-3000i
S/N     01234567
ID      ABCDEFG
DATE    2006/02/06
TIME    12:23:34
CAL.TEST(EXT.)
ACTUAL
      0.00 g
      +1999.99 g
TARGET
      +2000.00 g
SIGNATURE
-----
    
```

← Manufacturer →  
 ← Model →  
 ← Serial number →  
 ← ID number →  
 ← Date →  
 ← Time →  
 ← Calibration test type →  
 ← Zero point value →  
 ← Target weight value →  
 ← Target weight →  
 ← Signature →

### General data format

```

_____A_&_D<TERM>
MODEL___FX-3000i<TERM>
S/N_____01234567<TERM>
ID_____ABCDEFG<TERM>
DATE<TERM>
<TERM>
TIME<TERM>
<TERM>
CAL.TEST(EXT.)<TERM>
ACTUAL<TERM>
_____0.00__g<TERM>
_____+1999.99__g<TERM>
TARGET<TERM>
_____+2000.00__g<TERM>
SIGNATURE<TERM>
<TERM>
<TERM>
-----<TERM>
<TERM>
<TERM>
    
```

␣ Space, ASCII 20h  
 <TERM> Terminator, C<sub>R</sub>, L<sub>F</sub> or C<sub>R</sub>  
 C<sub>R</sub> Carriage return, ASCII 0Dh  
 L<sub>F</sub> Line feed, ASCII 0Ah

## Title block and end block

When a weight value is recorded as the GLP data, "Title block" and "End block" are inserted at the beginning and at the end of a group of weight values, in the GLP report.

### Note

To output the report to an AD-8121B, use **MODE 3** of the AD-8121B.

### Operation

- 1 With the weight data displayed, press and hold the **PRINT** key until **Start** is displayed. The "Title block" is output.
- 2 The weight data is output according to the parameter setting of the data output mode.
- 3 Press and hold the **PRINT** key until **RecEnd** is displayed. The "End block" is output.

When the setting is "info 1":

When the setting is "info 2":

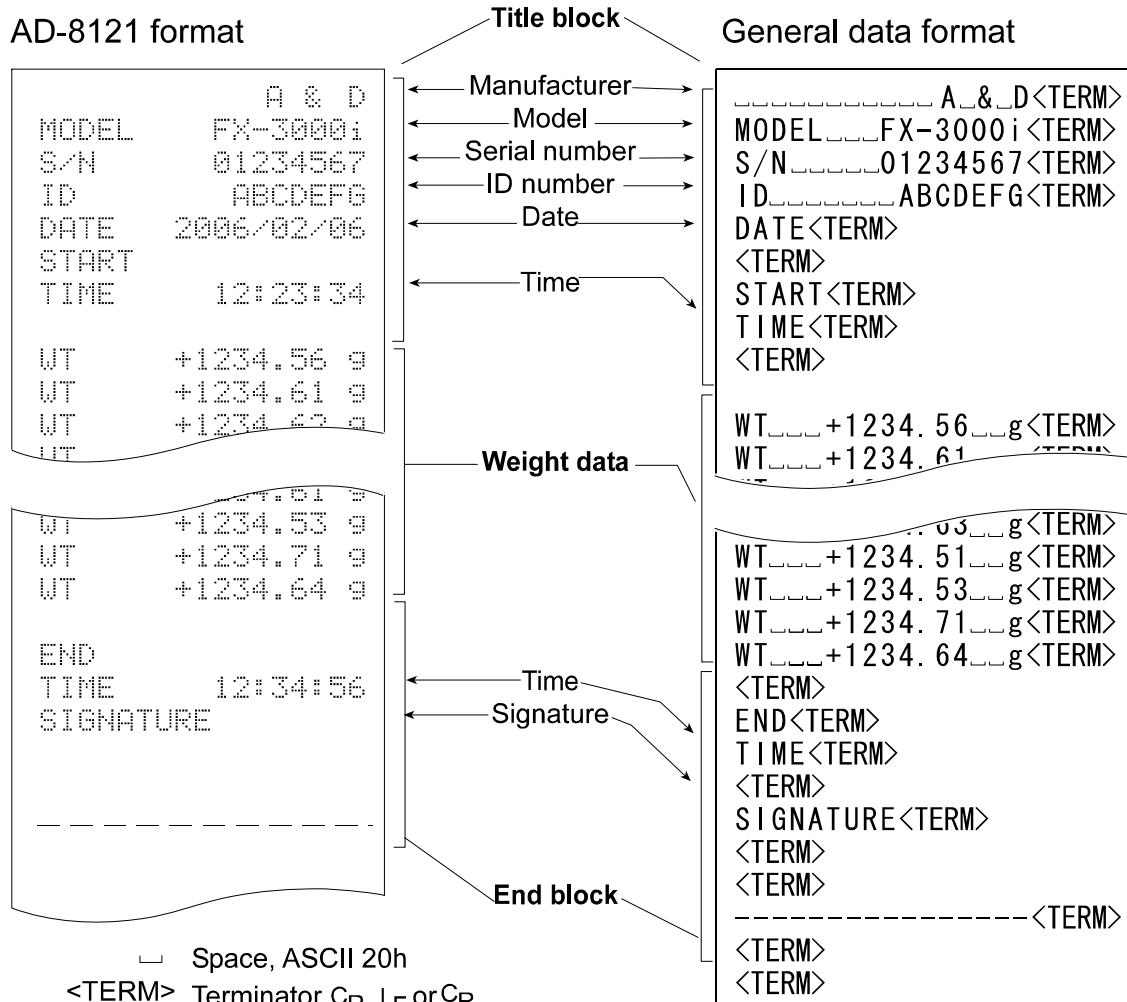

# 11. UNDERHOOK

The underhook can be used for magnetic materials or density measurement. The built-in underhook is revealed by removing the plastic cap on the bottom of the balance.

Use the underhook as shown below.

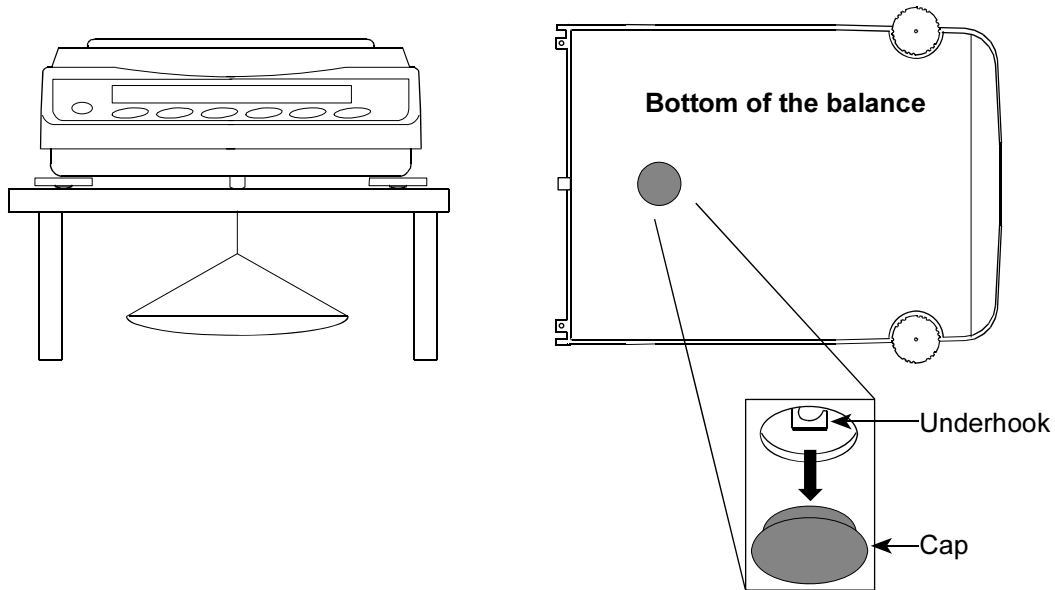

## Caution

**Do not apply excessive force to the underhook.**

**When not in use, attach the plastic cap to prevent dust from getting into the balance.**

## 12. PROGRAMMABLE-UNIT

This is a programmable unit conversion function. It multiplies the weight data in grams by an arbitrary coefficient set in the function table and displays the result.

The coefficient must be within the range between the minimum and maximum shown below. If the coefficient set is beyond the range, an error is displayed and the balance returns to the coefficient setting mode, prompting to enter an appropriate value. A coefficient of 1 was set at the factory.

Model	Minimum coefficient	Maximum coefficient
FX-120i /200i /300i	0.000001	1000
FX-1200i /2000i /3000i		100

### Operation

- 1 Press and hold the **SAMPLE** key until **bASFnC** of the function table is displayed.
- 2 Press the **SAMPLE** key several times to display **nLt**.
- 3 Press the **PRINT** key. The balance enters the mode to confirm or set the coefficient.

### Confirming the coefficient

- 4 The current coefficient is displayed with the first digit blinking.
  - When it is not to be changed, press the **CAL** key and proceed to step 6.
  - When it is to be changed, press the **RE-ZERO** key and proceed to step 5.

### Setting the coefficient

- 5 Set the coefficient using the following keys.

**SAMPLE** key To select a digit to change the value. The selected digit blinks.

**RE-ZERO** key To change the value.

**MODE** key To change the decimal point position.

Each time the switch is pressed, the decimal point position changes as follows:

→ 0.000001 → 00.00001 → ... → 000000.1 → 0000001 →

**PRINT** key To store the new setting, display **End** and go to step 6.

**CAL** key To cancel the new setting and go to step 6.

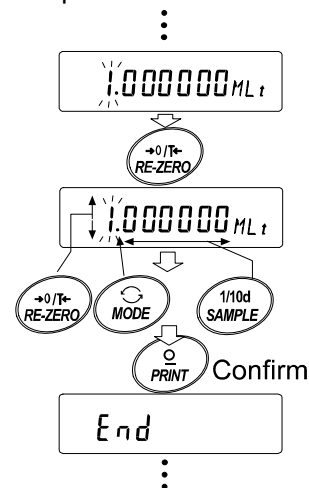

### Quitting the operation

- 6 The balance displays **Unit**. Press the **CAL** key to exit the programmable-unit function and return to the weighing mode.

### Using the function

Press the **MODE** key to select the programmable-unit (no display on the unit section). Perform weighing as described in “5-1 Basic Operation (Gram Mode)”. After weighing, the balance displays the result (weight data in grams x coefficient).



# 13. RS-232C SERIAL INTERFACE

The balance is a Data Communication Equipment (DCE) device. Connect the balance to a personal computer (DTE) using a straight through cable.

- Transmission system: EIA RS-232C (D-Sub 9-pin, female connector)
- Transmission form : Asynchronous, bi-directional, half duplex
- Transmission rate : 20 times/second, 10 times/second or 5 times/second (same as data refresh rate)
- Data format : Baud rate : 600, 1200, 2400, 4800, 9600, 19200 bps
  - Data bits : 7 or 8 bits
  - Parity : Even, Odd (Data bits 7 bits)
  - None (Data bits 8 bits)
  - Stop bit : 1 bit
  - Code : ASCII

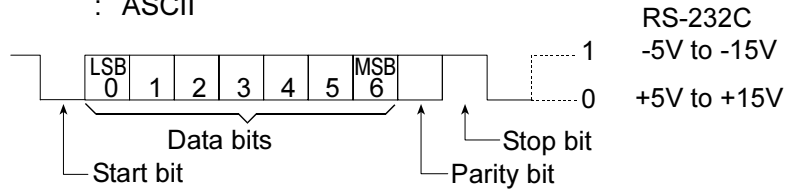

## D-Sub 9-pin assignments

Pin No.	Signal name	Direction	Description
1	-	-	No connection
2	TXD	Output	Transmit data
3	RXD	Input	Receive data
4	-	-	No connection
5	SG	-	Signal ground
6	DSR	Output	Data set ready
7	RTS	Input	Request to send
8	CTS	Output	Clear to send
9	-	-	No connection

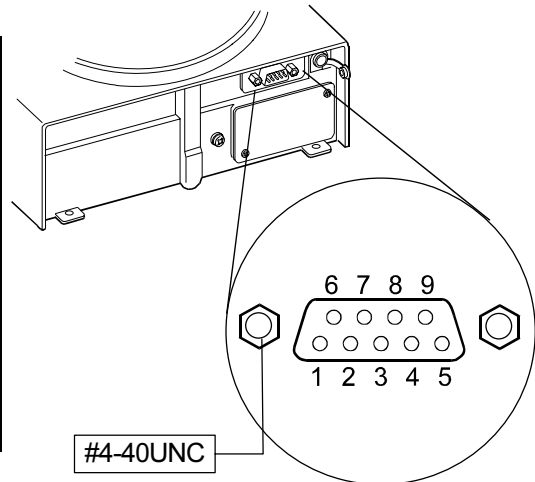

Signal names of the balance side are the same as the DTE side with TXD and RXD reversed.

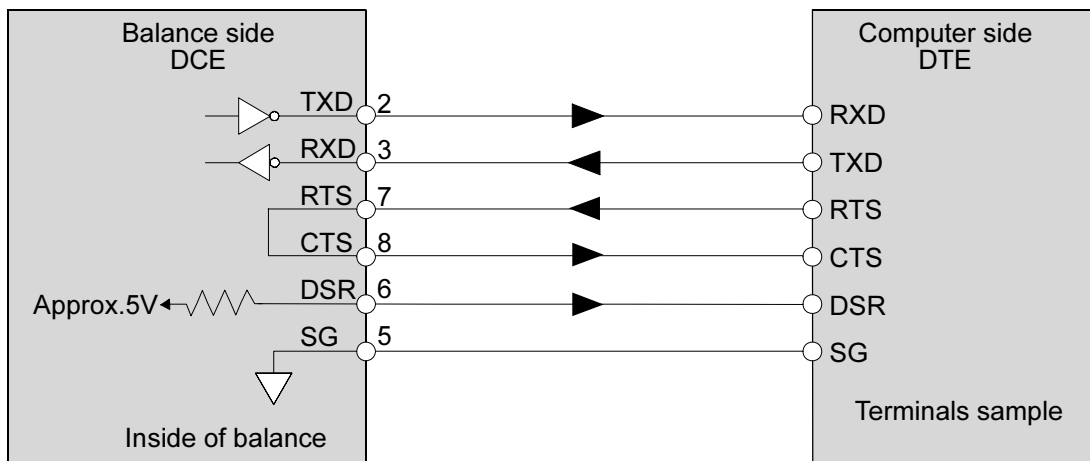

# 14. CONNECTION TO PERIPHERAL EQUIPMENT

## 14-1 Connection to the AD-8121B Printer

Set the following parameters to use the AD-8121B printer.

Example of use	AD-8121B mode setting
To print A&D standard format weight data, using the FX- <i>i</i> <b>PRINT</b> key or FX- <i>i</i> auto print mode. (The time and date can be added.)	MODE 1
To print A&D standard format weight data, using the AD-8121B <b>DATA</b> key or AD-8121B built-in timer. (The time and date can be added.) To print, using the AD-8121B chart printing function.	MODE 2
To print the FX- <i>i</i> statistical data.	MODE 3
To print GLP output.	MODE 3

Class	Item and Parameter	Factory settings	AD-8121B MODE 1	AD-8121B MODE 2	AD-8121B MODE 3
<i>dout</i> Data output	<i>Prt</i> Data output mode	0	0,1,2,4,5 *1	3	0,1,2,4,5 *1
	<i>PUSE</i> Data output pause	0	0	0	0,1 *2
<i>SIF</i> Serial interface	<i>bPS</i> Baud rate	2	2	2	2
	<i>btPr</i> Data bit, parity bit	0	0	0	0
	<i>CrLF</i> Terminator	0	0	0	0
	<i>TYPE</i> Data format	0	0	0	1

\*1 Set appropriate parameters for “*RP-P* (Auto print polarity)” and “*RP-b* (Auto print difference)” when auto print mode A or B (*Prt* 1 or 2) is selected.

Set the AD-8121B DIP switch No.3 to ON when unstable data is printed with “*Prt* 4”.

\*2 Set 1 when multiple lines are printed in the FX- *i* statistical calculation mode.

### Notes

Refer to “10-2 GLP Report” for print samples.

### Settings of AD-8121B DIP switches

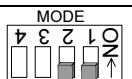
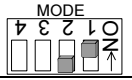
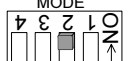
MODE	AD-8121B DIP switch	Description
MODE 1		Print at receiving data. Standard mode, statistical calculation mode
MODE 2		Print by the AD-8121B <b>DATA</b> key operation or AD-8121B built-in timer. Standard mode, interval mode, chart mode
MODE 3		Print at receiving data. Dump print mode

DIP switch No.3 : Handling unstable data

ON Print

OFF Not printed



Set the DIP switch No.4 to OFF.

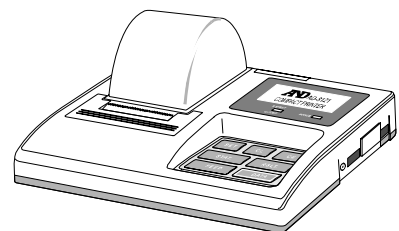
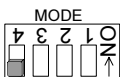

## 14-2 Connection to a Computer

---

The FX-*i* series balance can be connected to a personal computer using the RS-232C serial interface. As an option, the FX*i* -02 USB interface is available to transmit the balance data to a personal computer.

The FX-*i* series balance is a DCE.

Use a straight through cable. If purchasing the RS-232C cable on the market, check the interface connections and type.

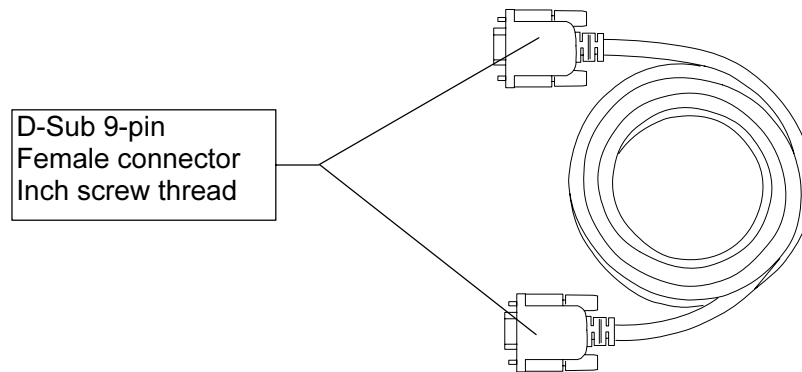

## 14-3 Using Windows Communication Tools (WinCT)

---

When Windows is used as an operating system in a personal computer, the WinCT software, that is downloaded from the A&D website, can be used to transmit the weight data to the personal computer.

The WinCT has two communication methods: "RsCom" and "RsKey".

### RsCom

- Can transmit commands to control the balance.
- Can make bi-directional communication between the balance and a personal computer using the RS-232C serial interface.
- Can display or store the data using a text file format. Can also print the data using a printer connected to the personal computer.
- When several ports of a personal computer have balances connected, can communicate with each balance simultaneously.
- Can share a personal computer with other application software.

### RsKey

- Can transmit the weight data output from the balance directly to other application software such as Microsoft Excel.
- Can be used with most application software.

**Using the WinCT software, the balance can do the following:**

- 1 Analyzing the weight data and the statistics with “RsKey”  
The weight data can be input directly into an Excel worksheet. Then, Excel can analyze the data to obtain sum, average, standard deviation, maximum and minimum value, and display them in a graph.
- 2 Controlling the balance using commands from a personal computer  
By using “RsCom”, the personal computer sends commands such as “re-zero” or “send weight data” to the balance and controls the balance.
- 3 Printing the balance GLP report using your printer  
The balance GLP report can be printed using a printer connected to the personal computer.
- 4 Receiving weight data at a certain interval  
The weight data can be received at a certain interval and data characteristic with elapsed time can be obtained.
- 5 Using a personal computer as an external indicator  
With the “RsKey” test mode function, a personal computer can be used as an external weight indicator for the balance. (To do this, set the balance data output mode to stream mode.)

# 15. COMMANDS

## 15-1 Command List

### Note

A command has a terminator added, that is specified using the "Terminator ( $\text{[rLF]}$ )" parameter of "Serial interface ( $\text{SIF}$ )" in the function table, and is sent to the balance.

### Commands to query weight data

<b>C</b>	Cancels the <b>S</b> or <b>SIR</b> command.
<b>Q</b>	Requests the weight data immediately.
<b>S</b>	Requests the weight data when stabilized.
<b>SI</b>	Requests the weight data immediately.
<b>SIR</b>	Requests the weight data continuously.
$\text{E}_{\text{sc}}$ <b>P</b>	Requests the weight data when stabilized.

Note: The "Q" and "SI" commands, the "S" and " $\text{E}_{\text{sc}}$ P" commands behave the same.

### Commands to control the balance

<b>CAL</b>	Same as the <b>CAL</b> key.
<b>OFF</b>	Turns the display off.
<b>ON</b>	Turns the display on.
<b>P</b>	Same as the <b>ON:OFF</b> key
<b>PRT</b>	Same as the <b>PRINT</b> key
<b>R</b>	Same as the <b>RE-ZERO</b> key
<b>SMP</b>	Same as the <b>SAMPLE</b> key.
<b>T</b>	Tare key
<b>Z</b>	Same as the <b>RE-ZERO</b> key
$\text{E}_{\text{sc}}$ <b>T</b>	Same as the <b>RE-ZERO</b> key
<b>U</b>	Same as the <b>MODE</b> key
<b>?ID</b>	Requests the ID number.
<b>?SN</b>	Requests the serial number.
<b>?TN</b>	Requests the model name.
<b>?PT</b>	Requests the tare weight.
<b>PT: *****. * <math>\text{[ ]}</math>g</b>	Changes the tare weight. The unit added is the current weighing unit in A&D standard format.

Note: The "R", "Z" and " $\text{E}_{\text{sc}}$ T" commands behave the same.

$\text{E}_{\text{sc}}$ : ASCII code 1Bh

## 15-2 Acknowledge Code and Error Codes

When the “AK, Error code (E<sub>r</sub>L<sub>d</sub>)” parameter of “Serial interface (S<sub>i</sub>F)” is set to “1”, the balance outputs <AK> code or an error code for each command as follows:

<AK> (06h) Acknowledge in ASCII code.

- When the balance receives a command to request data and can not process it, the balance transmits an error code (EC, Exx).  
When the balance receives a command to request data and can process it, the balance outputs the data.
- When the balance receives a command to control the balance and can not process it, the balance transmits an error code (EC, Exx).  
When the balance receives a command to control the balance and can process it, the balance transmits the acknowledge code.

Among commands to control the balance, the following transmit the acknowledge code both when the balance receives the command and when the balance has accomplished the command. If the command can not be processed properly, the balance transmits an error code (EC, Exx). This error can be released using the CAL command.

CAL command (Calibration command)                      ON command (Display ON command)

P command (Display ON/OFF command)                      R command (RE-ZERO command)

R command example

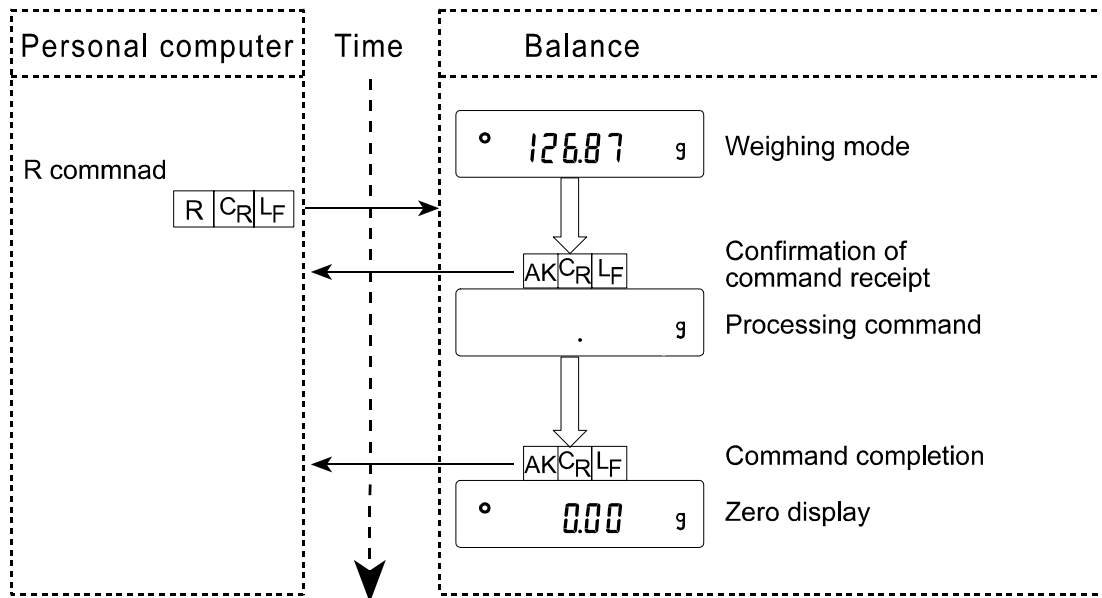

### T command example

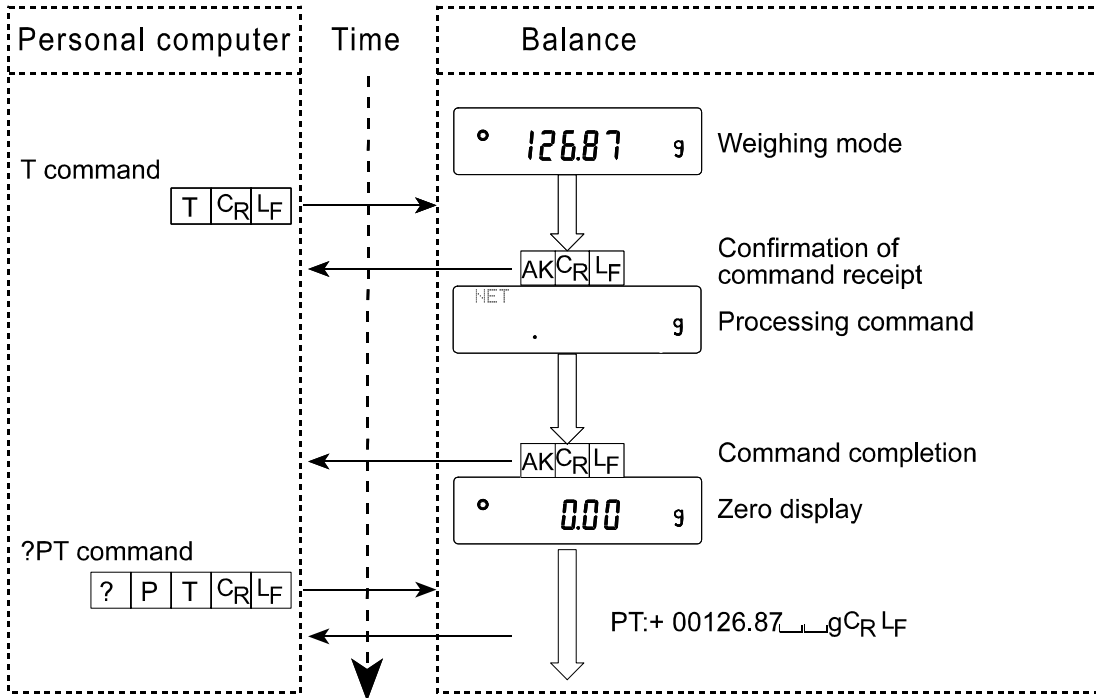

### PT command example

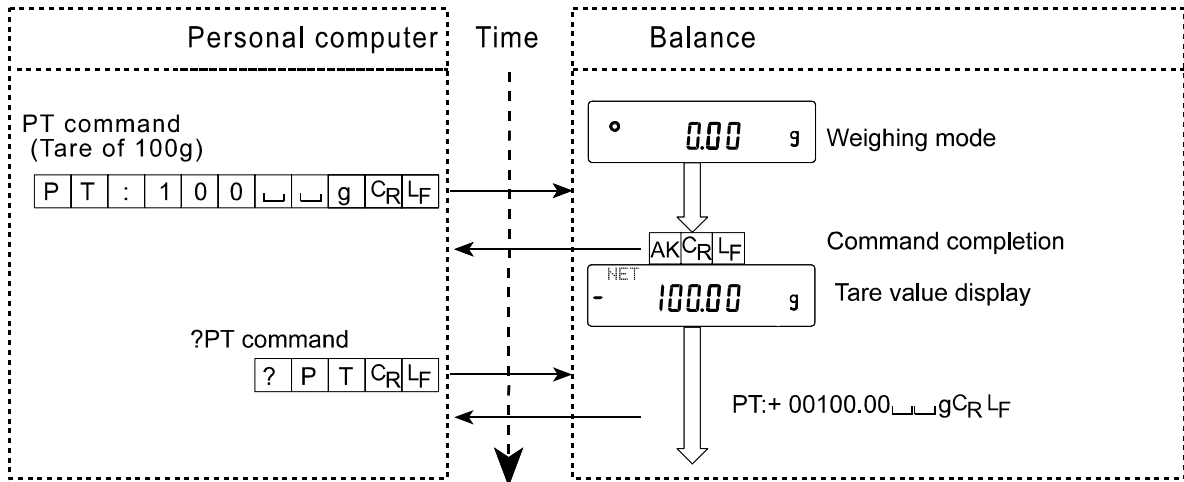

- When a communication error has occurred due to external noise, or a parity error has occurred due to transmission error, the balance transmits an error code. In this case, send the command again.

## 15-3 Settings Related to RS-232C

Concerning the RS-232C, the balance has two functions: "Data output ( *dout* )" and "Serial interface ( *SIF* )". Set each function as necessary.

## 16. MAINTENANCE

- Do not use organic solvents to clean the balance. Clean the balance with a lint free cloth that is moistened with warm water and a mild detergent.
- Do not disassemble the balance. Contact the local A&D dealer if the balance needs service or repair.
- Use the original packing material for transportation.



# 17. TROUBLESHOOTING

## 17-1 Checking the Balance Performance and Environment

The balance is a precision instrument. When the operating environment or the operating method is inadequate, correct weighing can not be performed. Place a sample on the pan and remove it, and repeat this several times. If the balance seems to have a problem with repeatability or to perform improperly, check as described below. If improper performance persists after checking, contact the local A&D dealer for repair.

### Checking that the balance performs properly

- Check the balance repeatability using an external weight. Be sure to place the weight in the center of the weighing pan.
- Check the balance repeatability, linearity and calibrated value using external weights with a known value.

### Checking that the operating environment or weighing method is proper

#### Operating environment

- Is the weighing table solid enough (especially for the FX-120*i* /200*i* /300*i*, the balance with a minimum weighing value of 0.001 g)?
- Is the balance level? Refer to “3-1 Before Use”.
- Is the operating environment free from vibration and drafts? For the FX-120*i* /200*i* /300*i*, has the breeze break been installed?
- Is there a strong electrical or magnetic noise source such as a motor near the balance?



#### Weighing method

- Is the weighing pan installed correctly?
- Is the **RE-ZERO** key pressed before placing a sample on the weighing pan?
- Is the sample placed in the center of the weighing pan?
- Has the balance been calibrated using an external weight?
- Has the balance been warmed up for 30 minutes before weighing?

#### Sample and container

- Has the sample absorbed or lost moisture due to the ambient conditions such as temperature and humidity?
- Has the temperature of the container been allowed to equalize to the ambient temperature? Refer to “3-2 During Use”.
- Is the sample charged with static electricity? Refer to “3-2 During Use”.  
The FX-120*i* /200*i* /300*i* is prone to be charged with static electricity when the relative humidity is low.
- Is the sample of magnetic material such as iron? Caution is required for weighing magnetic materials. Refer to “3-2 During Use”

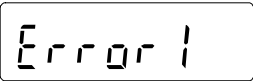
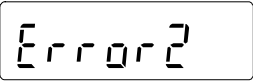
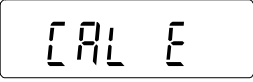
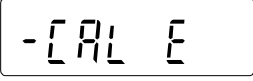
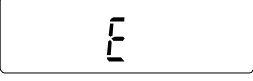
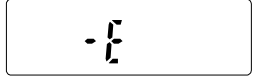
## 17-2 Error Codes

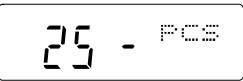
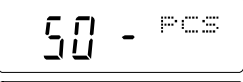
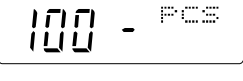
Display	Error code	Description
	<b>EC, E11</b>	<p><b>Stability error</b></p> <p>The balance can not stabilize due to an environmental problem. Prevent vibration, drafts, temperature changes, static electricity and magnetic fields.</p> <p>Refer to “3. PRECAUTIONS” for details on the operating environment and “6. RESPONSE ADJUSTMENT” about adapting the balance to the environment.</p> <p>To return to the weighing mode, press the <b>CAL</b> key.</p>
		<p><b>Out of range error</b></p> <p>The value entered is beyond the settable range. Re-enter the value.</p>
	<b>EC, E20</b>	<p><b>Calibration weight error</b></p> <p>The calibration weight is too heavy.</p> <p>Confirm that the weighing pan is properly installed. Confirm the calibration weight value.</p> <p>Press the <b>CAL</b> key to return to the weighing mode.</p>
	<b>EC, E21</b>	<p><b>Calibration weight error</b></p> <p>The calibration weight is too light.</p> <p>Confirm that the weighing pan is properly installed. Confirm the calibration weight value.</p> <p>Press the <b>CAL</b> key to return to the weighing mode.</p>
		<p><b>Overload error</b></p> <p>A sample beyond the balance weighing capacity has been placed on the pan.</p> <p>Remove the sample from the pan.</p>
		<p><b>Weighing pan Error</b></p> <p>The weight value is too light.</p> <p>Confirm that the weighing pan is properly installed and calibrate the balance.</p>
		<p><b>Sample mass error</b></p> <p>The balance can not store the sample for the counting mode or for the percent mode because it is too light.</p> <p>Use a sample that is heavier.</p>
  		<p><b>Unit mass error</b></p> <p>The sample unit mass for the counting mode is too light. Storing and using it for counting will cause a counting error.</p> <p>Add samples to reach the specified number and press the <b>PRINT</b> key.</p> <p>Pressing the <b>PRINT</b> key without adding samples will shift the balance to the counting mode. But, to acquire accurate weighing, be sure to add samples.</p>

Display	Error code	Description
	<b>EC, E00</b>	<b>Communications error</b> A protocol error occurred in communications. Confirm the format, baud rate and parity.
	<b>EC, E01</b>	<b>Undefined command error</b> An undefined command was received. Confirm the command.
	<b>EC, E02</b>	<b>Not ready</b> A received command can not be processed. e.g. The balance received a Q command, but not in the weighing mode. e.g. The balance received a Q command while processing a RE-ZERO command. Adjust the delay time to transmit a command.
	<b>EC, E03</b>	<b>Timeout error</b> If the timeout parameter is set to "t-UP 1", the balance did not receive the next character of a command within the time limit of one second. Confirm the communication.
	<b>EC, E04</b>	<b>Excess characters error</b> The balance received excessive characters in a command. Confirm the command.
	<b>EC, E06</b>	<b>Format error</b> A command includes incorrect data. e.g. The data is numerically incorrect. Confirm the command.
	<b>EC, E07</b>	<b>Parameter setting error</b> The received data exceeds the range that the balance can accept. Confirm the parameter range of the command.
<b>Other errors</b>		If the errors described above can not be released or other errors are displayed, contact the local A&D dealer.

## 17-3 Asking For Repair

If the balance needs service or repair, contact the local A&D dealer.

The balance is a precision instrument. Use much care when handling the balance and observe the following when transporting the balance.

- Use the original packing material.
- Remove the weighing pan from the main unit

# 18. OPTIONS

## Note

The *FXi-02*, *FXi-08* and *FXi-09* can not be used at the same time.

### *FXi-02* USB interface (Installed in the balance, Applicable OS: Windows 98 OSR2 or later)

- Used to transmit the balance weight data (numerical value only) uni-directionally to a personal computer via USB.
- Can transmit the balance weight data (numerical value only) directly to other application software such as Microsoft Excel, Word and memo pad.
- Driver installation is not necessary.

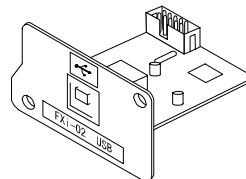

*FXi-02* Example of use

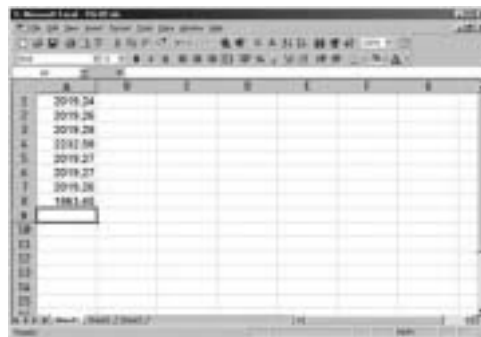

### *FXi-08* Ethernet interface

- Used to connect the balance to a LAN.
- The "WinCT-Plus" data communication software is provided as an accessory and can perform the following.
  - Acquire data from multiple balances connected to a LAN.
  - Control these balances with commands.
  - Acquire data transmitted from balances.  
Example: When pressing the **PRINT** key of the balance, data is output and is acquired by the computer.
  - The stored data can be used with Microsoft Excel (if installed).

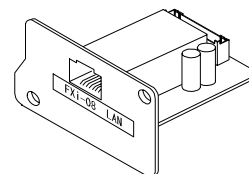

*FXi-08* Example of use

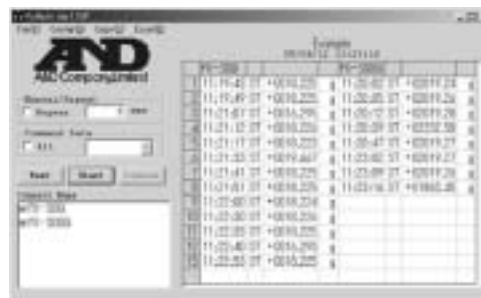

### *FXi-09* Built-in battery unit (Ni-HM rechargeable battery pack)

### *FXi-10* Small breeze break

- Provided for *FX-120i* /*200i* /*300i* as standard. Can be used for *FX-1200i* /*2000i* /*3000i*.

### *FXi-11* Large breeze break

- Breeze break with greater height. Can be used for all models. Convenient when a large beaker or measuring cylinder is used and requires more height.

### **AX-FXi-31 Main unit cover**

- Main unit protective cover provided as standard.

### **AD-1683 DC static eliminator**

- Used to minimize weighing errors due to static electricity on the material.

### **AD-8920 Remote display**

- Connected to the FX-*i* series balance using the RS-232C serial interface to display the weight data away from the balance.

### **AD-8922 Remote controller**

- Connected to the FX-*i* series balance using the RS-232C serial interface to display the weight data and to remotely control the balance.
- Analog output and comparator output available as an option to be installed.

### **AD-8121B Printer**

- Compact dot-matrix printer
- Statistical function, clock and calendar function, interval print function, graphic print function, dump print mode
- 5 x 7 dots, 16 characters per line
- Print paper (AX-PP143, 45 (W) x 50 (L) mm , ø65 mm)
- AC adapter or alkaline battery.

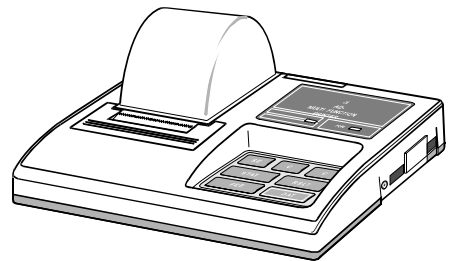

# 19. SPECIFICATIONS

	FX-120i	FX-200i	FX-300i	FX-1200i	FX-2000i	FX-3000i
Weighing capacity	122 g	220 g	320 g	1220 g	2200 g	3200 g
Maximum display	122.084 g	220.084 g	320.084 g	1220.84 g	2200.84 g	3200.84 g
Minimum weighing value (1 digit)	0.001 g			0.01 g		
Repeatability (Standard deviation)	0.001 g			0.01 g		
Linearity	±0.002 g			±0.02 g		
Stabilization time (typical at <b>FAST</b> )	Approx. 1 second					
Sensitivity drift (10°C-30°C/50°F-86°F)	±2 ppm/°C					
Operating environment	5°C to 40°C (41°F to 104°F) 85%RH or less (No condensation)					
Display refresh rate	5 times/second, 10 times/second or 20 times/second					
Counting mode	Minimum unit mass	0.001 g		0.01 g		
	Number of samples	5, 10, 25, 50 or 100 pieces				
Percent mode	Minimum 100% reference mass	0.100 g		1.00 g		
	Minimum 100% display	0.01%, 0.1%, 1% (Depends on the reference mass stored.)				
External calibration weight	100 g 50 g	200 g 100 g	300 g 200 g 100 g	1000 g 500 g	2000 g 1000 g	3000 g 2000 g 1000 g
Weighing pan diameter	130 mm			150 mm		
Net weight	Approx. 2.5 kg					
External dimensions	193 (W) x 262.5 (D) x 84.5 (H) mm					
AC adapter	Confirm that the adapter type is correct for the local voltage and power receptacle type					
Power consumption	Approx. 11VA (supplied to the AC adapter)					
Interface	RS-232C					

# 20. EXTERNAL DIMENSIONS

## FX-120i / 200i / 300i

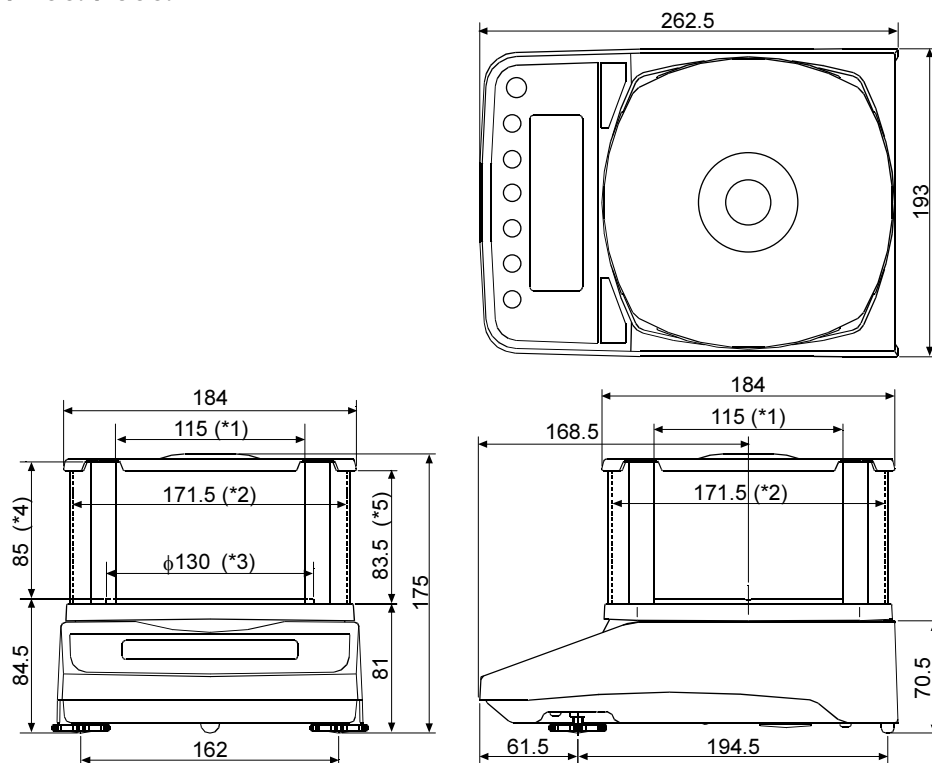

- \*1: Width of the opening when a clear plate is removed
- \*2: Inside dimension
- \*3: Weighing pan diameter
- \*4: Height from the weighing pan up to the cap of the breeze break (Inside dimension)
- \*5: Height of the opening when a clear plate is removed

## FX-1200i / 2000i / 3000i

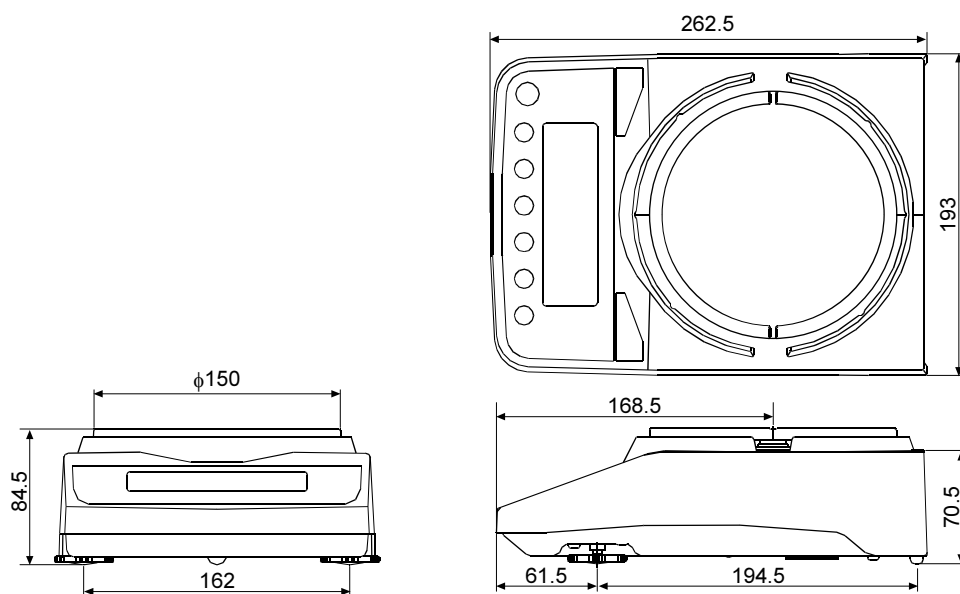

Unit: mm

## 21. TERMS/INDEX











### Terms

<b>Stable value</b>	The weight data when the stabilization indicator appears.
<b>Environment</b>	Ambient conditions such as vibration, drafts, temperature, static electricity and magnetic fields which affect the weighing operation.
<b>Calibration</b>	Adjustment of the balance so that it can weigh accurately.
<b>Output</b>	To output the weight data using the RS-232C serial interface.
<b>Zero point</b>	A weighing reference point or the zero display. Usually refers to the value displayed when nothing is on the weighing pan.
<b>Digit</b>	Unit of digital resolution. Used for the balance, a unit of minimum weighing value.
<b>Tare</b>	To cancel the weight of a container which is not included in the weight data.
<b>Mode</b>	Balance operational function.
<b>Re-zero</b>	To set the display to zero.
<b>GLP</b>	Good Laboratory Practice.
<b>Repeatability</b>	Variation in measured values obtained when the same weight is placed and removed repetitively. Usually expressed as a standard deviation. e.g. Standard deviation=1 digit: This means that measured values fall within $\pm 1$ digit in the frequency of about 68%.
<b>Stabilization time</b>	Time required after a sample being placed, until the stabilization indicator illuminates and the weight data is displayed.
<b>Sensitivity drift</b>	An affect that a change in temperature causes to the weight data. Expressed as temperature coefficient. e.g. Temperature coefficient = 2 ppm/ $^{\circ}\text{C}$ : If a load is 300 g and the temperature changes by $10^{\circ}\text{C}$ , the value displayed changes by the following value. $0.0002\%/^{\circ}\text{C} \times 10^{\circ}\text{C} \times 300 \text{ g} = 6 \text{ mg}$



# Index

## Keys and symbols

	ON/OFF key .....	8
	SAMPLE key .....	8
	MODE key .....	8, 9
	CAL key .....	8, 24, 26
	PRINT key .....	8
	RE-ZERO key .....	7, 8, 12
	Stabilization indicator .....	8
	Interval output mode active indicator .....	8
	Interval output mode standby indicator .....	8
	Processing indicator .....	8
$C_R$	CR .....	39
$L_F$	LF .....	39
$\_$	Space .....	39
	100% reference mass .....	15

## - A -

A&D standard format .....	33, 37
AC adapter .....	4
AC adapter ID label .....	4
ACAI .....	14
AD-1683 .....	6, 59
AD-8121B .....	44, 48, 59
AD-8920 .....	59
AD-8922 .....	59
AK .....	52
Animal mode indicator .....	8
$AP F_{nc}$ Application .....	16, 33
$AP-b$ Auto print difference .....	32
$APF$ Application function .....	16, 33
$AP-P$ Auto print polarity .....	32, 48
Application .....	16, 33
Application function .....	16, 33
$Ar-d$ Zero after output .....	32
$At-F$ Auto feed .....	32
Auto display-OFF .....	31, 35
Auto display-ON .....	31, 35
Auto print difference .....	32
Auto print mode A .....	32, 36
Auto print mode B .....	32, 36
Auto print polarity .....	32
$\overline{AVE}$ Average .....	18
Average .....	16, 18, 33
AX-FXi-13 .....	59

## - B -

$bASF_{nc}$ Environment display .....	11, 31
Baud rate .....	33, 47, 48
$bEEP$ Beep .....	31
$bEP^-$ HI buzzer .....	31
$bEP-$ LO buzzer .....	31
$bEP-$ OK buzzer .....	31
$bPS$ Baud rate .....	33, 48
Breeze break .....	4, 58
$bEP_r$ Data bit, parity bit .....	33, 48
Built-in battery unit .....	58

## - C -

$[CAL] E$ Calibration weight error .....	56
$-\overline{[CAL] E}$ Calibration weight error .....	56
$[CAL]$ key .....	8
Calibration .....	23, 24, 25, 29, 42, 56, 62
Calibration report .....	25, 42
Calibration test .....	26, 42
Calibration test report .....	27, 42
$[ArCEL]$ .....	18
Capacity indicator .....	8, 33, 40
$[LEAr]$ .....	18
Coefficient of variation .....	16, 18, 33
Command list .....	51
Comparator function .....	41
Comparator indicators .....	8
$[and]$ Condition .....	31, 34
Counting mode .....	13
$[P]$ Comparator mode .....	31
$[P F_{nc}]$ Comparator .....	31
$[P H_i]$ Upper limit .....	31
$[P L_o]$ Lower limit .....	31
$[rLF]$ Terminator .....	33, 48
CSV format .....	33, 38
$\sigma$ Coefficient of variation .....	18

## - D -

Data bits .....	47
Data format .....	33
Data output mode .....	32
Data output pause .....	32

DC static eliminator.....	59
DCE .....	47, 49
Decimal point.....	31, 35
Digit .....	31, 35, 62
Display at start.....	31
Display refresh rate.....	31, 35
<i>dout</i> Data output .....	32
DP format.....	33, 37
DTE .....	47

**- E -**

-E .....	56
EC, E00 .....	57
EC, E01 .....	57
EC, E02 .....	57
EC, E03 .....	57
EC, E04 .....	57
EC, E06 .....	57
EC, E07 .....	57
EC, E11 .....	56
EC, E20 .....	56
EC, E21 .....	56
End block.....	44
<i>ErCd</i> Error code .....	33
<i>Error 1</i> .....	56
<i>Error 2</i> .....	56
Ethernet interface .....	58
External dimensions .....	60, 61

**- F -**

<b>FAST</b> .....	22
Function table .....	30
FXi-02 .....	58
FXi-08 .....	58
FXi-09 .....	58
FXi-10 .....	58
FXi-11 .....	58

**- G -**

GLP .....	42
GLP output.....	23, 25, 26, 32, 42
Grounding terminal .....	4

**- H -**

<i>Hold</i> Hold function .....	31, 34
Hold function.....	31, 34

**- I -**

ID number .....	42
<i>info</i> GLP output.....	32
Inhibit .....	28
Initializing the balance.....	29
<i>int</i> Interval time .....	32
Interval output mode .....	32, 37
Interval output mode active indicator ...	8
Interval output mode standby indicator ...	8
Interval time .....	32

**- K -**

Key mode.....	32, 36
Key mode B .....	32, 36
Key mode C .....	32, 36
KF format .....	33, 38

**- L -**

Leveling foot .....	4
Linearity .....	60
<i>Lo</i> .....	56
Lower limit value .....	41

**- M -**

Main unit cover .....	4, 59
<b>MAX</b> Maximum .....	18
Maximum .....	16, 18, 33
Maximum display .....	60
<b>MID.</b> .....	22
<b>MIN</b> Manimum .....	18
Minimum .....	16, 18, 33
Minimum 100% reference mass .....	60
Minimum unit mass.....	60
Minimum weighing value.....	60
<b>MODE</b> key .....	8, 9, 11
MT format .....	33, 38

**- N -**

NET indicator .....	8
NU format .....	33, 38

Number of data ..... 16, 33

**- O -**

**ON:OFF** key ..... 8, 28  
Operating environment ..... 60

**- P -**

Pan support ..... 4  
Parity ..... 47  
**PCE** ..... 13  
Percent Mode ..... 15  
Permit ..... 28  
*Pnt* Decimal point ..... 31, 35  
*PoFF* Auto display-OFF ..... 31, 35  
*P-on* Auto display-ON ..... 31, 35  
**PRINT** key ..... 8, 11  
Printer ..... 48, 59  
Processing indicator ..... 8  
Programmable unit ..... 46  
*Prt* Data output mode ..... 32, 48  
*PUSE* Data output pause ..... 32, 48

**- R -**

**R** Range ..... 18  
Range ..... 16, 18, 33  
Remote controller ..... 59  
Remote display ..... 59  
Repeatability ..... 60  
Response indicators ..... 8, 22  
**RE-ZERO** key ..... 7, 8  
*rnG* Display at start ..... 31  
RS-232C ..... 47, 49  
RsCom ..... 49  
RsKey ..... 49

**- S -**

**SAMPLE** key ..... 8, 11  
**SD** Standard deviation ..... 18  
Sensitivity drift ..... 60  
*SIF* Serial interface ..... 33  
**SLOW** ..... 22  
*SPd* Display refresh rate ..... 31, 35

Stability band width ..... 34  
Stabilization indicator ..... 8, 11  
Stabilization time ..... 60  
Standard deviation ..... 16, 18, 33  
Standby indicator ..... 8  
*StRF* Statistical function mode output items 17, 33  
Statistical calculation mode ..... 3, 16, 33, 40  
Statistical function mode output items ..... 33  
*St-b* Stability band width ..... 31, 34  
Stop bit ..... 47  
Stream mode ..... 32, 36  
**SUM** Sum ..... 18  
Sum ..... 16, 18, 33

**- T -**

Tare ..... 12, 13, 15, 21  
Terminator ..... 33  
Timeout ..... 33  
Title block ..... 44  
Transmission form ..... 47  
Transmission rate ..... 47  
Transmission system ..... 47  
*Trc* Zero tracking ..... 31, 34  
*t-UP* Timeout ..... 33  
*tYPE* Data format ..... 33, 48

**- U -**

Underhook ..... 45  
Units ..... 8, 9, 11  
Upper limit value ..... 41  
USB interface ..... 58

**- W -**

Weighing ..... 12  
Weighing capacity ..... 7, 40, 56, 60  
Weighing pan ..... 4  
Weighing pan diameter ..... 60  
Weighing units ..... 9  
WinCT ..... 49

**- V -**

Zero tracking ..... 35











**A&D Company, Limited**

3-23-14 Higashi-Ikebukuro, Toshima-ku, Tokyo 170-0013 JAPAN  
Telephone: [81] (3) 5391-6132 Fax: [81] (3) 5391-6148

**A&D ENGINEERING, INC.**

1555, McCandless Drive, Milpitas, CA. 95035 U.S.A.  
Telephone: [1] (408) 263-5333 Fax: [1] (408)263-0119

**A&D INSTRUMENTS LTD.**

Unit 24/26 Blacklands Way, Abingdon Business Park, Abingdon, Oxon OX14 1DY United Kingdom  
Telephone: [44] (1235) 550420 Fax: [44] (1235) 550485

**<German Scales Office>**

Große Straße 13 b 22926 Ahrensburg GERMANY  
Telephone: [49] (0) 4102 459230 Fax:[49] (0) 4102 459231

**A&D MERCURY PTY. LTD.**

32 Dew Street, Thebarton, South Australia 5031 AUSTRALIA  
Telephone: [61] (8) 8301-8100 Fax: [61] (8) 8352-7409

**A&D KOREA Limited**

8th Floor, Manhattan Bldg. 36-2 Yoido-dong, Youngdeungpo-ku, Seoul, KOREA  
Telephone: [82] (2) 780-4101 Fax: [82] (2) 782-4280