

KILOTECH

Integrator C Operation Manual



Contents subject to change without notice
Version MAN021119-1.03

Ce manuel est disponible en français à www.kilotech.com

TABLE OF CONTENTS

TABLE OF CONTENTS	1
Introduction	2
General Precautions	3
Specifications	4
Outline	4
Unpacking and setup	5
Contents	5
Display and keypad	6
Faceplate	6
Symbols on Display	6
Keypad.....	7
Layout and characters	7
Key combinations.....	8
Weighing operations	9
Key functions.....	9
Store/program PLU's	10
Recall PLU	12
Recall direct PLU.....	12
Recall indirect PLU's	12
Miscellaneous transaction	12
Parameter setting	13
Business name	13
LCD contrast	14
Auto off	14
Internal code	15
Communication settings	15
Set date and time.....	17
Group code.....	18
Back feed.....	18
Origin setting.....	19
LCD test	19
Format of barcode for printing	20
RS-232 cable pinout for host	20
Printer cable pinout (OS-203/213)	20
Error codes	21
Communication output format	22
Host	22
Print format with OS-203 / 213 printer.....	22
Available Label formats.....	22
Display Character Reference	23
Troubleshooting	24

Introduction

Thank you for choosing a Kilotech Scale. We appreciate your business and hope that you will enjoy using your scale. Should you require support, please contact your local dealer from whom you have purchased. Happy Weighing!

General Precautions

Avoid lengthy exposure to heat or cold.	Allow the scale to acclimate to normal room temperature before use.
Allow sufficient warm up time.	Turn the scale on and wait for a few minutes to allow the internal components a chance to stabilize before weighing.
Do not leave a load or weight on a scale for a prolonged period of time.	
Do not tamper with the scale yourself.	This will void the warranty. Contact your local distributor to properly repair your scale.
Do not disassemble the scale yourself.	This will void the warranty. Contact your local distributor to properly repair your scale.
Do not load beyond max cap the maximum weight limit.	
Do not pull the plug by its cord when unplugging.	
Do not use the scale near fire or corrosive gas.	
Do not spill water or immerse in water.	
Avoid placing the scale near a heater.	It could cause a fluctuation to the indicator reading.
Always make sure to use a Kilotech approved adapter.	
Do not drop the scale or apply a sudden shock.	
Do not drag the scale.	
Avoid exposing to other electromagnetic devices.	These devices emit RF and can cause unstable readings. If your scale should perform poorly, try moving the scale to a different room or location.
Level the scale or make sure it is on an even surface.	A scale used on an uneven surface may provide an unstable reading.
Scale should be used within stated temperature & humidity limits.	

Specifications

Product Number		
Product Name	C15	C30
Capacity	15kg / 30lb / 480oz	30kg / 60lb / 960oz
Graduation	0-6 kg:2g/6-15kg: 5g 0-15lb:0.005lb/15-30lb:0.01lb 0-240oz:0.1 oz /240-480oz:0.2 oz	0-15kg:5g/15-30kg:10g 0-30lb: 0.01lb/30-60lb:0.02lb 0-480oz:0.2 oz/480-960oz:0.5 oz
Weighing Modes	kg, lb, oz	
Display	0.73",18 digits : 6 digit for weight reading, 6 digit for unit price, 6 digit for total price	
Back Light	Yes and adjustable	
Auto Power Off	Yes	
Power	12Vdc ≥500mA with positive center AC adaptor	
Battery	6Vdc4AH lead-acid battery	
Product Dimensions	355 × 370 × 131mm/ 14" x 14.6" x 5.2"	
Platter Size	335 × 225mm / 13" x 8.9"	
Operating Temperature /	0° C - 40° C / 32° F - 104° F / <90% RH non condensing	
Unit price range	0.00 - 9999.99 \$/kg or \$/lb	
Total price range	0-999.99\$ (limited by bar code)	
RS232	RS232(optional) USB(virtual RS232,optional)	
Real Time Clock	Yes	
PLU	265 including 5 direct PLU (Addr: 1-5)	
Measurement Canada and NTEP		

Outline

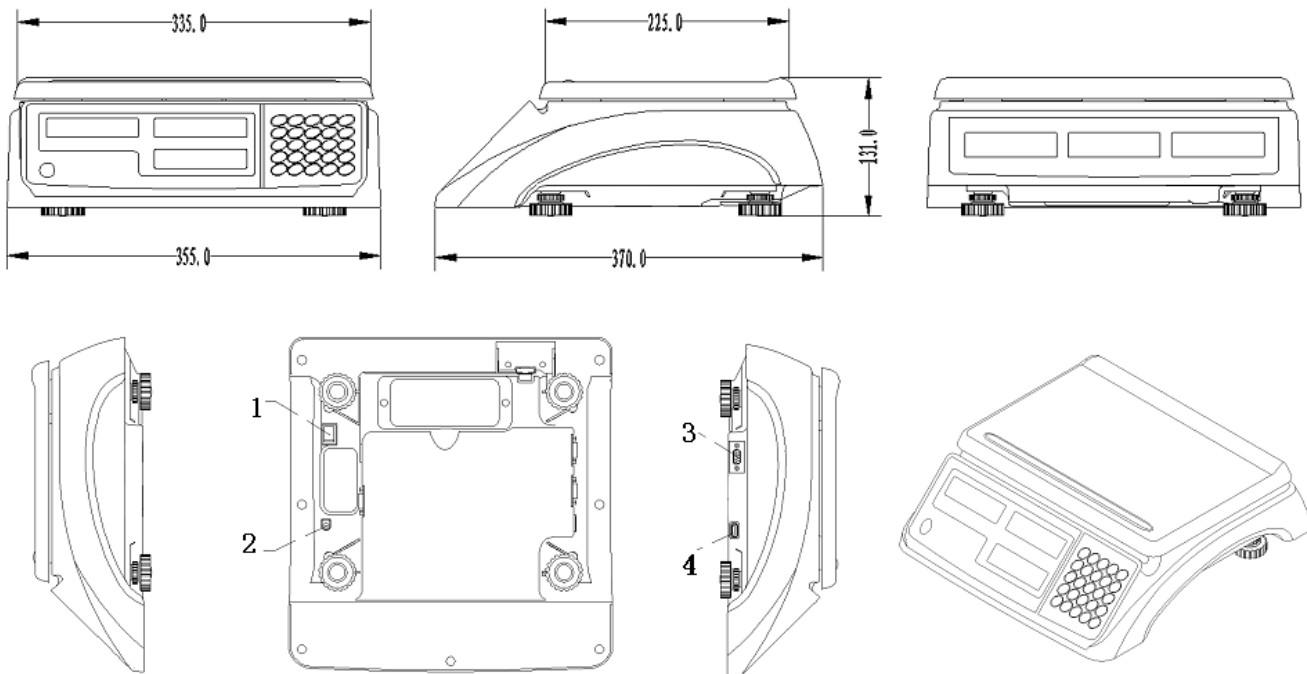

Interface: (1) Main switch (2) AC power adapter input (3-4) RS232 and USB

Unpacking and setup

- Remove the scale from the box and place it on a firm, level surface.
- Avoid locations with rapid temperature changes, excessive dust, moisture, air currents, vibrations, electromagnetic fields, heat or direct sunlight.
- Adjust the leveling feet until the bubble is centered in the circle of the level indicator (located on the front panel).

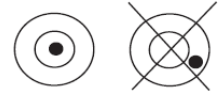

- NOTE: Ensure that the scale is level each time its location is changed.
- Before using the scale for the first time, the internal rechargeable battery should be fully charged for at least 12 hours.
- Connect the supplied AC adapter to the power input receptacle underneath the scale. Plug the AC adapter into a power outlet and the battery will begin charging.
- If the scale will be stored or transported in the future, save the packaging material to ensure the best possible protection for the scale.

Contents

- Scale
- 6Vdc4AH lead-acid battery (installed in scale housing)
- 12Vdc/500mA UL adapter with positive center
- Manual

Display and keypad

Faceplate



Symbols on Display

- **WEIGHT** - Weight display window
- **→0←** - Centre-of-zero annunciator
- **↕** - TARE annunciator
- **kg/lb/oz** - Weight unit annunciator
- **UNIT PRICE** - Unit price display window
- **💾** - Save mode annunciator
- **\$/kg/\$/lb/\$/oz** - Unit price per kg/lb /oz annunciator
- **TOTAL PRICE(\$)** - Total price display window
- **🖨** - Data output annunciator
- **🔋** - Charging annunciator
- **🔌** - AC Adapter in-use annunciator

Keypad

0 Alt Gr - **9** : numeric keys, Used to enter numerical data or alphabets

M1 - **M5** : Direct PLU keys, Used to directly recall the stored unit price

CLEAR : Clear the recorded data

ENTER : Confirm the operation or data entered

 : Save the tare weight and/or unit price

→0← : Used to set the scale to zero

 : Used to tare the scale.

ST PLU : Enter program PLU mode

RC PLU : Enter recall PLU mode

 : Transmit data to the communication port

UNIT : Used to switch between units

 : Turns the scale on and off and functions as exit key in programming mode





Layout and characters



0 <small>Alt Gr</small>	0 space () ÀÂÆÇÈÉÊË Î ÏÒÙÛÜ	1 <small>ABC</small>	1ABC
2 <small>DEF</small>	2DEF	3 <small>GHI</small>	3GHI
4 <small>JKL</small>	4JKL	5 <small>MNO</small>	5MNO
6 <small>PQRS</small>	6PQRS	7 <small>TUV</small>	7TUV
8 <small>WXYZ</small>	8WXYZ	9	9



Key combinations



Press both key simultaneously and hold down for more than three seconds.

(for details on these operations, please see their respective sections in the manual)



 +  : Used to enter the business's name setup mode



 +  : Used to enter the LCD's contrast setup mode

 +  : Used to enter the auto-off time setup mode

 +  : Used to display A/D inner code or working voltage

 +  : Used to enter RS232 parameters setup mode

 +  : Used to enter the date and time setup mode

 +  : Used to enter Group Code setup mode

 +  : Used to set OS-203/213 Back Feed setup mode

 +  : Used to enter OS-203/213 Origin setup mode

 +  : Enter LCD test mode

Weighing operations

Key functions



Power on/off

- When the scale is off, first make sure the power switch on the bottom of the right hand side of the scale is ON. Press on/off key to power on the scale.
- Press on/off for more than 3s to power off the scale.



Zero

- The zero key is used to zero out the small difference on the weight display.
- The scale will display "Err" when the weight to be zeroed is outside the range
- If a tare is set, the ZERO key function is not available



Tare

- Weight tare: Place the receptacle (box, bowl etc...) on the scale, and when the reading is stable, press tare key to tare the weight.
- Key tare: Key in known tare weight and press tare key.
- To clear Zero or Tare, press their respective buttons.
- The tare weight and unit price will be auto cleared after transaction is completed and item has been removed from the platter.



Save

- When activated, this function will prevent auto clearing of the unit price or tare-weight.
- When active, the save indicator is activated.



Units key

- Use the key to shift between "kg", "lb", "oz". Note: Unit price will be set to zero during switching
- You cannot switch units when a tare is active.























Print

- Used to transmit the data over the RS232 or USB. When the price has been computed, press print key output the data via RS232 according to the setting style to make a price label. (see appendix for layout example)

Store/program PLU's

To cancel and return to normal mode at any time, press 



Weight Display	Total Price Display	Unit Price Display	Keys used	Comment
0.00	0.00	0.00	Press  to start	
St.PLU	ADDR		Enter address using numerical keys  ~  To confirm press 	The system will overwrite any previous data The address range is from 1 to 265 1-5 is for direct unit price
St.PLU	NAME		Enter product name using numerical key  ~  To confirm press 	Use the numerical keys to select the letter needed Only the last six characters will show Max length is 20 characters
St.PLU	INGRDT		Enter ingredients using numerical keys  ~  To confirm press 	This field is only visible when activated (PRTd60, PRDnd6) Max 80 characters
St.PLU	LIFE		Enter shelf life using numerical keys  ~  To confirm press 	Refers to shelf life of the product. Max number of days = 253
St.PLU	"Unit.0" (kg) or "Unit.1" (lb)		Use the  key to switch To confirm press 	

Weight Display	Total Price Display	Unit Price Display	Keys used	Comment
St.PLU	UNIT.P		Enter price using numerical keys  To confirm press 	
St.PLU	Tare		Enter tare weight using numerical keys  To confirm press 	
St.PLU	ITEM.C		Enter item code using numerical keys  To confirm press 	If the PLU data has been changed, the unit price window will briefly display “Save” and the total price window will briefly display “Data.ch” .





Repeat the steps for the next PLU or press  to return to the normal weighing mode.

Recall PLU



Recall direct PLU

Recall a PLU that is stored under a speed key by pressing   key, the stored unit price will be displayed in unit price window. The total price window will display “DUP. xx”, and then the actual total price will appear.

Recall indirect PLU's

Icon	Weight Display	Total Price Display	Unit Price Display	Confirm or Exit	Comment
	rc.PLU	ADDR	<p>Enter the unit price using numerical keys</p>  ~  ie010. The address range is from 1 to 265,	<p>To confirm press</p>  <p>To exit and return to regular weighing mode Press</p> 	<p>The unit price window will display the recalled unit price. The total price window displays “PLU.xxx”(xxx is the Address) and then will go back to the normal total price displaying mode later, using the new unit price, tare weight, new weight unit, trade name, and shell life)</p>

Miscellaneous transaction

Use the numerical keys  ~ , to enter unit price (range: 0000.00 ~ 9999.99).









The programmed price can be cleared by pressing the  key.

The unit price will be cleared automatically after weighing and removing the objects.









Parameter setting

To cancel and return to normal mode at any time, press the  key





Business name

Weight Display	Total Price Display	Unit Price Display	Keys used	Comment
0.00	0.00	0.00	Press both  +  simultaneously and hold down for more than three seconds	
bUSI.N1		XXXXXXXXXXXX	Enter first line of Business name using numerical key  ~  To confirm press 	Displays the last 12 characters Max length is 20 characters
bUSI.N1		XXXXXXXXXXXX	Enter second line of Business name using numerical key  ~  To confirm press 	



LCD contrast

Weight Display	Total Price Display	Unit Price Display	Keys used	Comment
0.00	0.00	0.00	Press both  +  simultaneously and hold down for more than three seconds	
Setup	LCd.CST	X	 ~  To confirm press 	X = value currently set
Setup	BLGT.MD	x	 ~  To confirm press 	0 = always on 1 = always off 2 = Automatic

Auto off







Weight Display	Total Price Display	Unit Price Display	Keys used	Comment
0.00	0.00	0.00	Press both  +  simultaneously and hold down for more than three seconds	
Setup	A.OFF.t	XX	 ~  To confirm press 	XX = value currently set in minutes Max delay = 30 min 00 = auto off disabled

















Internal code





Weight Display	Unit Price Display	Total Price Display	Keys used	Comment
0.00	0.00	0.00	Press both  +  simultaneously and hold down for more than three seconds	
UoL.x.x	CodE	xxxxxx		UoL.x.x = working voltage Code = A/D internal count

Communication settings

To cancel and return to normal mode at any time, press the  key
The settings in bold are default





Weight Display	Unit Price Display	Total Price Display	Keys used	Comment
0.00	0.00	0.00	Press both  +  simultaneously and hold down for more than three seconds	
Setup	232.out	xxxxxx	Chose format using numerical keys  ~  To confirm press 	Communication format options. 0 = HOST: 1 = PRTd40 2 = PRTd60 3 = PRTNd4 4 = PRTNd6 (see appendix for details)
Setup	232.bps	xxxxxx	Choose baud rate using numerical keys  ~  To confirm press	baud rate options 1 = 1200bps 2 = 2400bps 3 = 4800bps 4 = 9600bps 5 = 19200bps

Weight Display	Unit Price Display	Total Price Display	Keys used	Comment
				
Setup	232.dFt	XXX	Choose parity rate using numerical keys  ~  To confirm press 	Parity options 1 = 8N1 2 = 7O1 3 = 7E1
Setup	Prtd.Ft	XXXXXX	Choose format using numerical keys  ~  To confirm press 	0 = CANADA YY-MM-DD 1 = USA DD-MMM-YY 2 = Num Numerical format
Setup	B.PRT.FT	XXXX	Choose format using numerical keys  ~  To confirm press 	0 = 514P 1 = 4I5P 2 = 5I5P 3 = 4I6P See Appendix for details barcode formats
Setup	USB.oUt	XXXX	Choose format using numerical keys  ~  To confirm press 	0 = None USB disabled 1 = Host, USB activated .
Setup	Usb.bps	XXXXX	Choose baud rate using numerical keys  ~  To confirm press 	baud rate options 1 = 1200bps 2 = 2400bps 3 = 4800bps 4 = 9600bps 5 = 19200bps





Weight Display	Unit Price Display	Total Price Display	Keys used	Comment
Setup	Usb.dft	XXX	Choose baud rate using numerical keys  To confirm press 	Format options 1 = 8N1 2 = 7O1 3 = 7E1
Setup	Urt.CFt	XXX	Choose format setting using numerical keys  To confirm press 	0 = None 1 = S-N Data will be transmitted when the print key is pressed and scale is stable

The system will automatically reboot after changing the above parameter settings





Set date and time

Weight Display	Unit Price Display	Total Price Display	Keys used	Comment
0.00	0.00	0.00	Press both  simultaneously and hold down for more than three seconds	.
Setup	dAtE	xx.xx.xx	Enter date using numerical keys  To confirm press 	format: YY.MM.DD
Setup	timE	xx.xx.xx	Enter time using numerical keys  To confirm press 	Format: hh.mm.ss





Group code

Weight Display	Unit Price Display	Total Price Display	Keys used	Comment
0.00	0.00	0.00	Press both  +  simultaneously and hold down for more than three seconds	
Setup	GroUP.C	XX	Enter time using numerical keys  ~  To confirm press 	Default = 00 Range = 00~99







Back feed

Weight Display	Unit Price Display	Total Price Display	Keys used	Comment
0.00	0.00	0.00	Press both  +  simultaneously and hold down for more than three seconds	
Setup	bAk.FEd	XXXXXX	Choose mode using numerical keys  ~  To confirm press 	Printer must be on and connected 0 = disable 1 = enable

Origin setting

Weight Display	Unit Price Display	Total Price Display	Keys used	Comment
0.00	0.00	0.00	Press both  simultaneously and hold down for more than three seconds	
Setup	orG	XXX	Set value using numerical keys  To confirm press 	Default: 0 Range = 0-255
Setup	orG Y	XXX	Set value using numerical keys  To confirm press 	Default: 0 Range = 0-255

LCD test

Weight Display	Unit Price Display	Total Price Display	Keys used	Comment
0.00	0.00	0.00	Press both  simultaneously and hold down for more than three seconds. Press  key to exit	Press: (a)  - show all segments. (b)  - show different segments. (c)  - show segments on different COMs. (d)  - show segments of a-b-c steps

Format of barcode for printing

No.	Format	Type	1	2	3	4	5	6	7	8	9	10	11	12	13
0	5I4P	EAN13	G	G	I	I	I	I	I	S	P	P	P	P	C
1	4I5P	EAN13	G	G	I	I	I	I	S	P	P	P	P	P	C
2	5I5P	EAN13	G	G	I	I	I	I	I	P	P	P	P	P	C
3	4I6P	EAN13	G	G	I	I	I	I	P	P	P	P	P	P	C

NOTE: If the fields ("Price" and "Item code") are greater than the parameters set, "OUT.P.R" (indicates it is out of printing range) will appear in the weight window.

i.e. you enter 5 digits in a field that needs to be 4 digits.

G: Group Code;

I: Item Code;

S: Check-sum for price;

P: Total Price (If the weight window displays zero, it will be the unit price);

C: Check-sum for all characters;

RS-232 cable pinout for host

SCALE	-----CABLE(9 pins)-----	HOST
DB9(Female)	-----DB9(Male)-----DB9(Female)-----	DB9(Male)
PIN2 TXD	-----2-----2-----	PIN2 RXD
PIN3 RXD	-----3-----3-----	PIN3 TXD
PIN5 GND	-----5-----5-----	PIN5 GND
PIN4 DSR	-----4-----4-----	PIN4 DTR
PIN6 DTR	-----6-----6-----	PIN6 DSR
PIN7 CTS	-----7-----7-----	PIN7 RTS
PIN8 RTS	-----8-----8-----	PIN8 CTS
PIN1 NC	-----1-----1-----	PIN1 NC
PIN9 NC	-----9-----9-----	PIN9 NC

NOTE: PIN4 and PIN6, PIN7 and PIN8 are shorted in the scale

Printer cable pinout (OS-203/213)

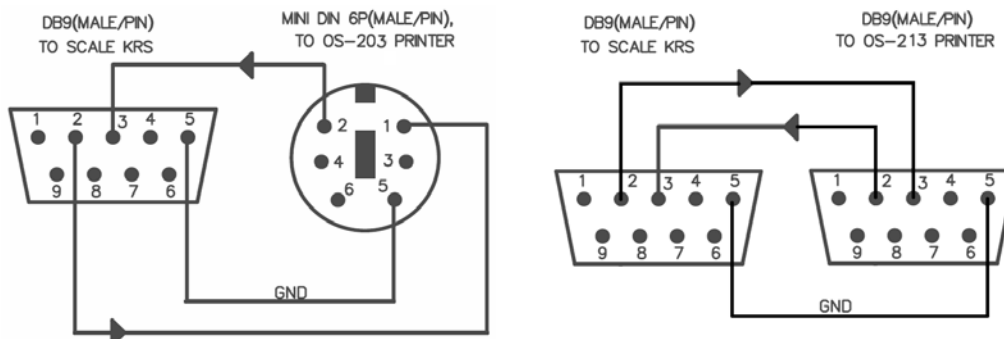

Error codes

Err01:	The weight signal is too large.
Err02:	No proper data can be displayed.
Err03:	The weight signal is too small.
Err04:	Zero point is over the setting range.
Err05:	Zero point is below the setting range.
Err06:	Error in unit key operation.
Err10:	The EEPROM can't be accessed.
Err11:	The parameters are not same with backup data.
Err12:	The setting parameter(s) is not in normal range.
Err20:	There is an error in calibration.
Err30:	ADC is over max. range.
Err31:	ADC is below min. range.
Err40:	Recall error, no content stored.
CAP.:	Capacity.
UOL.:	Voltage.
St.PLU:	To set and store the indirect unit price.
ADDR. :	PLU address.
Unit:	Weighing unit selecting.
Rc.PLU:	Recall indirect unit price.
OUT.P.R:	Data is out of printed barcode range.
Data.ch:	Data has been changed.
Save:	Data is being saved.
O.RANGE:	The data has been entered or the weight for tare weight is out of range.

Communication output format

Host

Group Code: xx
 Date: yy-mm-dd
 Time: hh:mm:ss
 Gross: xxxx.xxx kg/lb/oz
 Tare: xxx.xxx kg/lb/oz
 Net: xxxx.xxx kg/lb/oz
 Unit Price: xxxxxx.xx \$/kg(\$/lb,
 \$/oz)
 Total Price: xxxxxx.xx \$

Print format with OS-203 / 213 printer

Commodity name			
Ingredients			
EAN13 bar code	①	②	③
	⑤	④	
Price/Price		TOTAL \$	
Business name			

- ① Pack date
- ② Sell date
(Sell date = Pack date + life)
- ③ Weight
- ④ Total price
- ⑤ Unit price

Available Label formats

1: **PRTd40** = 58mm × 40mm with date

PINEAPPLE			
0 200010 000322	Packed on Emballe le	Sell by Vendre avant	Weight/Poids
	16.01.09 21.01.09	0.126kg	
2.55\$/kg		\$0.32	
Price/Price		TOTALS	
KILOTECH 3245 JB DESCHAMPS			

3: **PRTNd4** = 58mm × 40mm without date

PINEAPPLE			
0 200010 000322	Packed on Emballe le	Sell by Vendre avant	Weight/Poids
			0.126kg
2.55\$/kg		\$0.32	
Price/Price		TOTALS	
KILOTECH 3245 JB DESCHAMPS			

2: **PRTd60** = 58mm × 60mm with date

CROUSTADE AUX POMMES POMMES JUS DE CITRON SUCRE FARINE CANNELLE LAIT			
0 200012 005888	Packed on Emballe le	Sell by Vendre avant	Weight/Poids
	11.10.26	11.10.27	0.648kg
5.99\$/kg		\$3.88	
Price/Price		TOTALS	
KILOTECH 3245 JB DECHAMPS			

4: **PRTNd6** = 58mm × 60mm without date

CROUSTADE AUX POMMES POMMES JUS DE CITRON SUCRE FARINE CANNELLE LAIT			
0 200012 005888	Packed on Emballe le	Sell by Vendre avant	Weight/Poids
			0.648kg
5.99\$/kg		\$3.88	
Price/Price		TOTALS	
KILOTECH 3245 JB DECHAMPS			

Display Character Reference

Symbol	7-segments digit	Symbol	7-segments digit	Symbol	7-segments digit	Symbol	7-segments digit	Symbol	7-segments digit
0		C		O		(ï	
1		D		P)		ô	
2		E		Q				ù	
3		F		R		À		û	
4		G		S		Â		ü	
5		H		T		Æ			
6		I		U		Ç			
7		J		V		È			
8		K		W		É			
9		L		X		Ê			
A		M		Y		Ë			
B		N		Z		Ï			

Troubleshooting

Troubleshooting		Possible causes	Solution
Power-on problem	No display after pressing the power on button	<ul style="list-style-type: none"> Batteries failed No electricity Adapter or plug is not inserted properly. Main switch is off 	<ul style="list-style-type: none"> Check if the batteries Check the power supply with the adapter and ensure the adapter is plugged in properly at both ends Turn on main switch
		Key button is not working	Contact your supplier
	Display irregular characters after you press a button	LCD or its driver IC are not soldered well, or are damaged; or some keys are not free to move down or up	Contact your supplier
	Display 888888, does not revert back to 0		
Err	Err04	<ul style="list-style-type: none"> Zero point signal is over or below the limitation There are objects on the platform Load cell is not at zero balance One foot is not level with the others 	<ul style="list-style-type: none"> Remove the objects on the platform Adjust the foot to be level with the other feet. Using the leveling indicator to assist. Contact your supplier
	Err05		
	Err20	<ul style="list-style-type: none"> Load cell has no output The signal is too small or too large Scale is not stable Input incorrect number or loaded wrong load 	<ul style="list-style-type: none"> Contact your supplier
	Err01	<ul style="list-style-type: none"> The weight exceed 9d of the max capacity The load cell output signal is too big 	<ul style="list-style-type: none"> Empty platter and check for obstruction Contact your supplier
	Err31 Err30	The load cell signal is too small or too large.	<ul style="list-style-type: none"> Contact your supplier
	Err11	EEPROM on the PCB broken	Replace with new PCB
	Display Lo.bAt	Voltage lower than 5.7V	<ul style="list-style-type: none"> Charge the battery Contact your supplier for a new battery
	Capacity not accurate	Linearity is not accurate	<ul style="list-style-type: none"> The platform is not installed level The four feet are not level The load cell is broken There are some objects between load cell and scale.
Big error between the corners		<ul style="list-style-type: none"> The platform is not installed level The four feet are not level The load cell is broken There are some objects between load 	<ul style="list-style-type: none"> Make sure the platform is level Make sure the four feet are level Clear the objects between load

Troubleshooting		Possible causes	Solution
		cell and scale.	cell and scale <ul style="list-style-type: none"> • Contact your supplier
	Inconsistent readings	<ul style="list-style-type: none"> • The platform is not installed level • Broken load cell • Aging problem with PCB • There is some objects between load cell and scale. 	<ul style="list-style-type: none"> • Make sure the platform is level • Make sure the four feet are level • Clear the objects between load cell and scale • Contact your supplier
Function problem	Key button(s) is/are not functioning	<ul style="list-style-type: none"> • Key button(s) is/ are not working • 	<ul style="list-style-type: none"> • Contact your supplier
	Communication is erratic	<ul style="list-style-type: none"> • Communication wire is broken • The interface is broken 	<ul style="list-style-type: none"> • Replace the communication wire • Contact your supplier